

## INSTALL ALARM KIT

**Step 1:** Disassemble device if it was installed on door. Remove dogging cover plate.

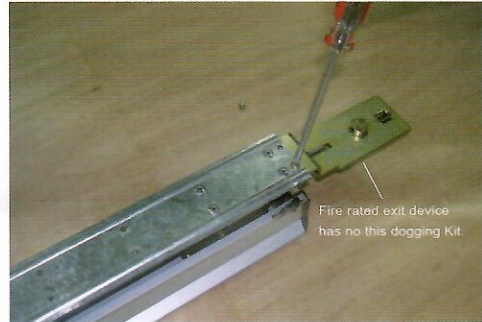

**Step 4:** Turn device over and release two fixing screws of dogging kit.



**Step 2:** Remove head cover from device chassis.



**Step 5:** Mount alarm kit on same position with dogging kit.

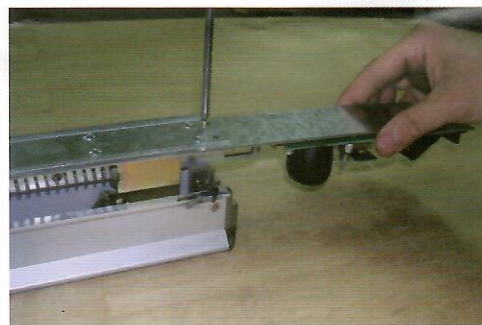

**Step 3:** Remove device mechanism housing.



**Note:** If installing the latch monitor switch, refer to page 6. If not, continue to Step 6.

**Step 6:** Release two fixing screws of push bar end cap.

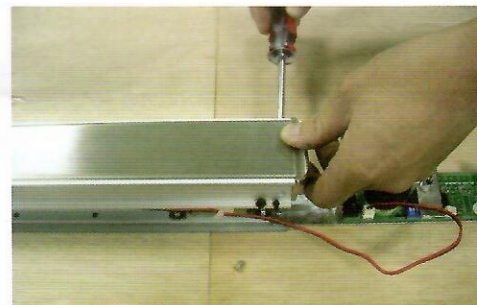

Step 7: Slide push bar trim plate out of push bar.

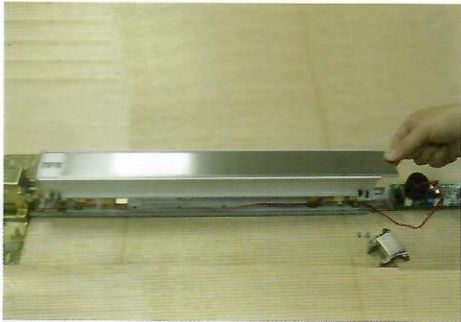

Step 10: Slide mechanism housing back onto device.



Step 8: Slide in provided push bar trim plate with red printed cautionary note.



Step 11: Install switch support plate and tighten by a switch nut.

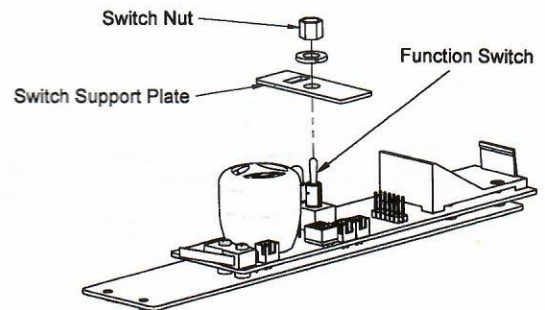
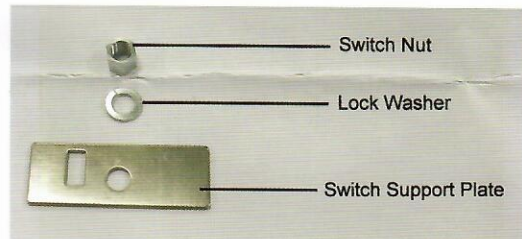

Insert the round hole of this switch support plate into function switch, then use the switch nut to tighten it.

Step 9: Mount push bar end cap back.

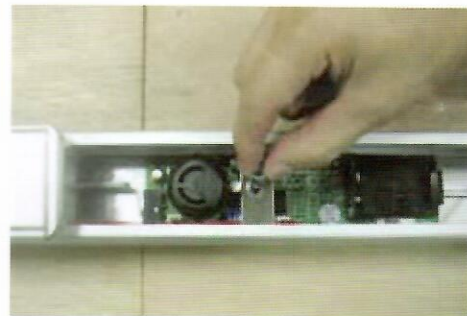

**Note:** If installing tamper switch, refer to page 8. If not, continue to Step 10.

Step 12: Put one 9V lithium battery into battery housing as shown.

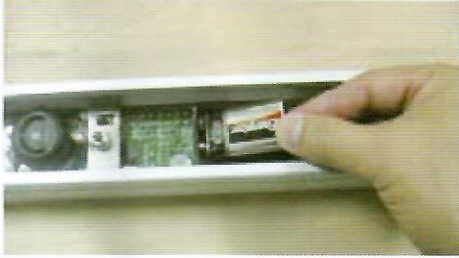

### GENERAL INSTALLATION INSTRUCTIONS

Step 1: Install finished alarm device on door. For more details, see installation instructions and templates.



Step 3: Turn on power switch, red LED light will come on to show device in Alarm ON mode at this time.

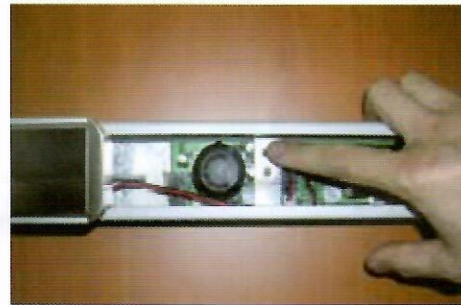

Step 2: Install tamper switch bracket & end cap bracket together at same position.

Step 4: Set a length of alarm time on DIP switch.

**Note: If not installing tamper switch, install Standard end cap bracket.**



To sound alarm for 1 minute, push Lever 1 to ON position.

To sound alarm for 3 minutes, push Lever 2 to ON position.

To sound alarm for 5 minutes, push Lever 3 to ON position.

To sound alarm continuously, push all levers to OFF position (factory default).



**Step 5: Install cylinder on provided device cover plate that has horn holes. Slide it onto device.**

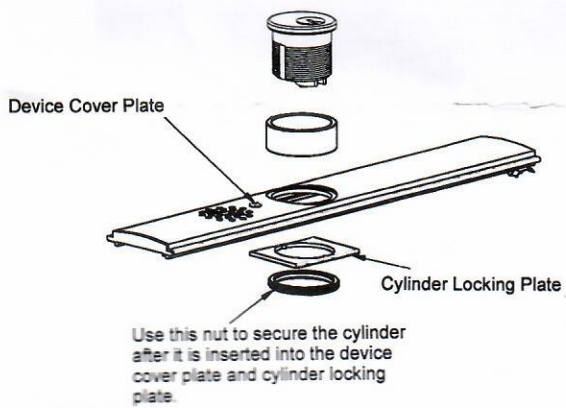
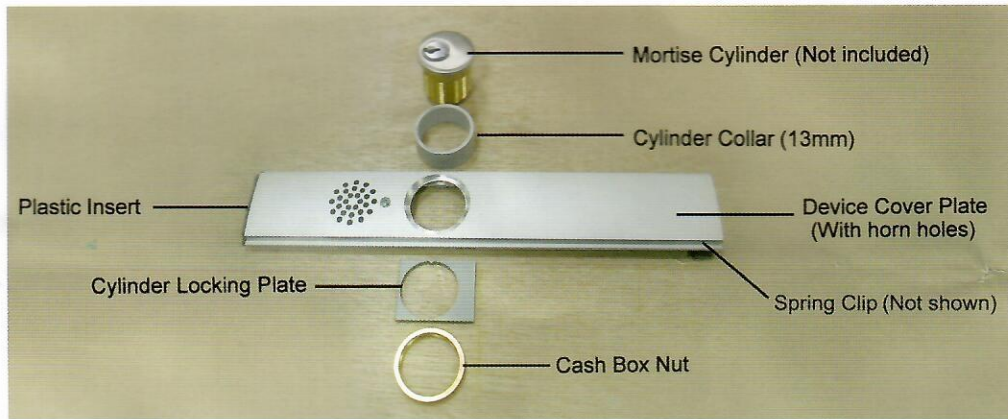

**Step 6: Mount head cover and end cap, if removed.**

