

The Design and Construction Requirements of the Fair Housing Act: Technical Overview



Participant Manual



(888) 341-7781 (V/TTY) - Technical Guidance
www.FairHousingFIRST.org

2005-2006



Designed and Developed by:

**The BearingPoint Team
for
U.S. Dept. of Housing and Urban Development
C-OPC-22667
October 2005**

**Government Technical Representative for HUD:
Cheryl Kent, Special Advisor for Disability Policy,
Office of Fair Housing and Equal Opportunity**

The BearingPoint Team

BearingPoint, Inc.

Sara K. Pratt, Civil Rights and
Fair Housing Consultant

Phillip Zook, Phillip Zook Architect

Doug Anderson, LCM Architects

Jack Catlin, LCM Architects

Kate Copeland, Silver State Fair Housing
Council

Rebecca Ingram, Rebecca Ingram Architect

George D. Williams, Diversity Dynamics LLC

William Worn, William Worn Architects, P.C.

Rex Pace, Universal Design Solutions

Technical Requirements of the Fair Housing Act

Participant Manual Table of Contents

Using the Participant Manual	2
Overview of the Fair Housing Act	3
Technical Requirements of the Fair Housing Act	20
Strategies for Compliance	140
Resources	150

Using the Participant Manual

Manual Layout and Content

As a participant in the course, the Participant Manual serves as your focal point. It follows the sequence of the class activities and discussion topics. It includes:

- All slides presented by the instructor
- Space for you to take notes
- Key points not contained on slides
- Detailed instructions for exercises
- Resources to supplement the curriculum



Welcome to Fair Housing Accessibility FIRST, a training and technical guidance program created by the U.S. Department of Housing and Urban Development (HUD).

This session is three hours in length with one break.

Fair Housing Accessibility

FIRST

- Offer training and technical guidance on accessibility requirements of the Fair Housing Act

- Increase the supply of accessible multifamily housing units nationwide

Notes:

Fair Housing Accessibility

FIRST



Gathered opinions and ideas from over 850 stakeholders

Stakeholder Groups

- Builders
- Disability rights advocates
- Government officials
- Trade associations
- Property managers
- Media
- Code officials
- Enforcement agencies

Notes:

Fair Housing Accessibility FIRST

- Comprehensive training curriculum
- Technical guidance via a website and toll free hotline
 - 1-888-341-7781 V/TTY
 - www.FairHousingFIRST.org

Notes:

Technical Overview

During this training session, we will discuss:

- Overview of the Fair Housing Act
- Safe Harbors for Compliance with the Technical Requirements of the Fair Housing Act
- Overview of the Technical Requirements of the Fair Housing Act

Notes:

Technical Overview

During this training session, we will discuss:

- Detailed technical specifications and requirements of the Fair Housing Act's Design and Construction requirements
- Requirements Suggestions for achieving compliance with the Fair Housing Act
- Resources to turn to when you need more information

Notes:

Technical Overview

At the end of the session, you will be able to:

- Describe the Fair Housing Act's design and construction requirements
- List the types of properties that are subject to the Fair Housing Act
- Apply the Fair Housing Act technical requirements to future design and construction
- Find and use available resources to obtain additional information and assist with accessible design and construction questions

Notes:

History of the Fair Housing Act

- Fair Housing Act was passed in **1968**
- Fair Housing Amendments Act, with new coverage of disability, was enacted in **1988**
- Enforced by:
 - The Department of Housing and Urban Development
 - The Department of Justice
 - State and local fair housing enforcement agencies
 - Private lawsuits in federal and state courts



Notes:

Units Covered by the Fair Housing Act

- The design and construction requirements apply to “covered multifamily dwellings” designed and constructed for first occupancy after **March 13, 1991**

- Covered multifamily dwellings include:***
 - All dwelling units in buildings containing four or more units, with an elevator
 - All ground floor units in buildings containing four or more units, without an elevator

Notes:

Housing That is NOT Covered

- Housing that is **not** covered by the design and construction requirements of the Act:
 - Detached single family houses
 - Duplexes or triplexes
 - Multistory townhouses

What is NOT covered by the Design and Construction Requirements

Detached single family houses are not covered by the Fair Housing Act's design and construction requirements regardless of when they are built. Units that contain two or three units in a building (duplexes and triplexes) are also not covered by the design and construction requirements of the Fair Housing Act. They do not contain at least four units in a building.

Multistory townhouses that contain living space on more than one floor are not covered by the requirements. However, there are two situations where multistory townhouses are covered.

If an interior elevator provides access within an individual multistory townhouse, the townhouse is covered.

If a multistory townhouse is located in a building that has one or more public elevators, the primary entrance level of a multistory townhouse must be the level served by the elevator, and that level must comply with other Fair Housing Act requirements for access, including providing an accessible bathroom or powder room on that level.

The Fair Housing Act covers all units in buildings with elevators, not just the units on floors served by elevators. This requirement is found in the Guidelines, Requirement 1, para. (3)(a)(1)(ii).

Fair Housing Act – Seven Design and Construction Requirements

1. Accessible building entrance on an accessible route
2. Accessible and usable public and common use areas
3. Usable doors
4. Accessible routes into and through covered unit
5. Light switches, electrical outlets, thermostats, and other environmental controls in accessible locations
6. Reinforced walls in bathrooms for later installation of grab bars
7. Usable kitchens and bathrooms



Fair Housing Act – Seven Design and Construction Requirements

The Fair Housing Act's design and construction requirements are broken down into seven basic requirements.

1. Accessible building entrance on an accessible route
2. Accessible and usable public and common use areas
3. Usable doors
4. Accessible routes into and through covered unit
5. Light switches, electrical outlets, thermostats, and other environmental controls in accessible locations
6. Reinforced walls in bathrooms for later installation of grab bars
7. Usable kitchens and bathrooms

The requirements provide for a minimal level of accessibility. Congress, when it passed these requirements, said that it intended that the accessibility provisions of the Fair Housing Act would facilitate the ability of persons with disabilities to enjoy full use of their homes without imposing unreasonable requirements on homebuilders, landlords and residents without disabilities. Congress stated that compliance with these basic requirements would eliminate many of the barriers that discriminate against persons with disabilities in their attempts to have equal housing opportunities.

Technical Requirements of the Fair Housing Act

Fair Housing Act—Seven Design and Construction Requirements (continued)

The design and construction requirements were developed to provide access for people with different types of disabilities. Although some of the requirements focus on people who use wheelchairs, meeting the requirements will also meet the needs of many other people. People who can benefit from accessible features may include people with arthritis or sports injuries who have difficulty turning or gripping door hardware, people who use crutches, canes or walkers, people who because of age or illness have limited mobility or reach ranges, and even people who push strollers, carry groceries, or move furniture. People who have vision or hearing disabilities also benefit from a variety of provisions in the requirements.

Notes:

**Fair Housing Act – Seven Design and Construction Requirements
(continued)**

1. The first is that all covered multifamily dwellings must have ***at least one building entrance on an accessible route*** unless it is impractical to do so because of the terrain or unusual characteristics of the site.
 - An accessible route means a continuous, unobstructed path connecting accessible elements and spaces within a building or site that can be negotiated by a person with a disability who uses a wheelchair, and that is also safe for and usable by people with other disabilities.
 - An accessible entrance is a building entrance connected by an accessible route to public transit stops, accessible parking and passenger loading zones, or public streets and sidewalks.
2. The second requirement is that ***covered housing must have accessible and usable public and common use areas***. Public and common use areas cover all parts of the housing outside individual units. They include, for example: building-wide fire alarms, parking lots, storage areas, indoor and outdoor recreational areas, lobbies, mailrooms and mailboxes, and laundry areas.
3. The third requirement is that all ***doors that allow passage into and within all premises must be wide enough to allow passage by persons using wheelchairs***.
4. The fourth requirement is that ***there must be an accessible route into and through each covered unit***.
5. The fifth requirement is that ***light switches, electrical outlets, thermostats and other environmental controls must be in accessible locations***.
6. The sixth requirement is ***reinforcements in bathroom walls so that grab bars can be added when needed***. The law does not require installation of grab bars in bathrooms.
7. The seventh requirement is that ***kitchens and bathrooms must be usable***— that is, designed and constructed so an individual in a wheelchair can maneuver in the space provided.

Fair Housing Act – Safe Harbors for Compliance

1. HUD Fair Housing Accessibility Guidelines and the Supplemental Notice
2. ANSI A117.1 (1986), used with the Fair Housing Act, HUD's regulations, and the Guidelines
3. CABO/ANSI A117.1 (1992) used with the Fair Housing Act, HUD's regulations, and the Guidelines
4. ICC/ANSI A117.1 (1998) used with the Fair Housing Act, HUD's regulations, and the Guidelines
5. The Fair Housing Act Design Manual (1998)
6. Code Requirements for Housing Accessibility 2000 (ICC/CRHA)
7. International Building Code 2000 with 2001 Supplement
8. International Building Code 2003, with one condition*

Fair Housing Act – Safe Harbors for Compliance

There are eight safe harbors for compliance with the Fair Housing Act. Compliance with any one of the eight will fulfill the Fair Housing Act's access requirements.

If a particular safe harbor is chosen for use in a particular property, housing must comply with all of the provisions of that safe harbor in order for there to be a safe harbor. So it is unwise to pick and choose among the provisions of different safe harbor standards.

These are the eight access standards that HUD has identified as safe harbors:

1. *The Fair Housing Act Accessibility Guidelines* (issued on March 6, 1991), and the Supplemental Notice to Fair Housing Accessibility Guidelines: Questions and Answers about the Guidelines (issued June 28, 1994).
2. *ANSI A117.1 (1986)*, used with the Fair Housing Act, HUD's Fair Housing Act regulations, and the Guidelines.
3. *CABO/ANSI A117.1 (1992)*, used with the Fair Housing Act, HUD's Fair Housing Act regulations, and the Guidelines.

**Fair Housing Act –
Safe Harbors for Compliance (continued)**

4. *ICC/ANSI A117.1 (1998)*, used with the Fair Housing Act, HUD's Fair Housing Act regulations, and the Guidelines.
5. *The Fair Housing Act Design Manual (1998)*.
6. *Code Requirements for Housing Accessibility 2000 (CRHA)*, published by the International Code Council in October, 2000.
7. *International Building Code 2000 (IBC)*, as amended by the IBC's 2001 Supplement to the International Codes.
8. *International Building Code 2003(IBC)*, with one condition.*

- * Effective February 28, 2005 HUD determined that the IBC 2003 is a safe harbor, conditioned upon ICC publishing and distributing a statement to jurisdictions and past and future purchasers of the 2003 IBC stating, "ICC interprets Section 1104.1, and specifically, the exception to Section 1104.1, to be read together with Section 1107.4, and that the Code requires an accessible pedestrian route from site arrival points to accessible building entrances, unless site impracticality applies. Exception 1 to Section 1107.4 is not applicable to site arrival points for any Type B dwelling units because site impracticality is addressed under Section 1107.7."

It is important to note that the ANSI A117.1 standard contains only technical criteria, whereas the Fair Housing Act, the regulations and the Guidelines contain both scoping and technical criteria. Therefore, in using any of the ANSI standards it is necessary to also consult the Act, HUD's regulations, and the Guidelines.

Other means of providing access that provide an equal or greater degree of accessibility may also be used to comply with the Fair Housing Act's access requirements, but they are not a safe harbor.

This training relies on the provisions of the Fair Housing Act, the Guidelines and Supplemental Questions and Answers, ANSI A117.1 (1986) and the Fair Housing Act Design Manual for the guidance that it provides about compliance with the technical design and construction requirements in the Act.

Notes:

CAUTION:

Safe harbor standards constitute safe harbors only when adopted and implemented in accordance with the policy statement that HUD published in the Federal Register on March 23, 2000. That policy statement notes, for example, that if a jurisdiction adopts a model building Code that HUD has determined conforms with the design and construction requirements of the Act, then covered residential buildings that are constructed in accordance with plans and specifications approved during the building permitting process will be in compliance with the requirements of the Act unless the building code official has waived one or more of those requirements or the building code official has incorrectly interpreted or applied the building code provisions. In addition, adoption of a HUD recognized safe harbor does not change HUD's responsibility to conduct an investigation if it receives a complaint.

Safe Harbors Used in this Training

1. HUD Fair Housing Accessibility Guidelines and the Supplemental Notice, used with the Fair Housing Act and HUD's regulations
2. ANSI A117.1 (1986), used with the Fair Housing Act, HUD's regulations, and the Guidelines
3. The Fair Housing Act Design Manual (1998)

Safe Harbors Used in this Training

This training relies on the provisions of the Fair Housing Act and its regulations, the Accessibility Guidelines and the Supplemental Questions and Answers, ANSI A117.1 (1986) and the Design Manual for the guidance that it provides about compliance with the technical design and construction requirements in the Act.

Notes:

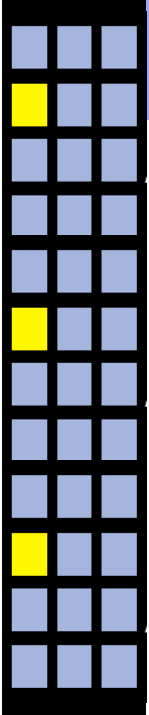

Technical Overview - Agenda

- Overview of the Fair Housing Act
- **Technical Requirements of the Fair Housing Act**
 - Requirement 1
 - Requirement 2
 - Requirement 3
 - Requirement 4
 - Requirement 5
 - Requirement 6
 - Requirement 7
- Strategies for Compliance
- Resources

Notes:

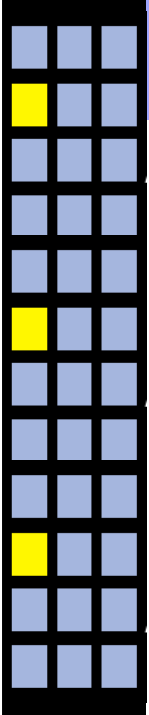

Technical Overview - Agenda

- Overview of the Fair Housing Act
- **Technical Requirements of the Fair Housing Act**
 - **Requirement 1**
 - Requirement 2
 - Requirement 3
 - Requirement 4
 - Requirement 5
 - Requirement 6
 - Requirement 7
- Strategies for Compliance
- Resources

Notes:

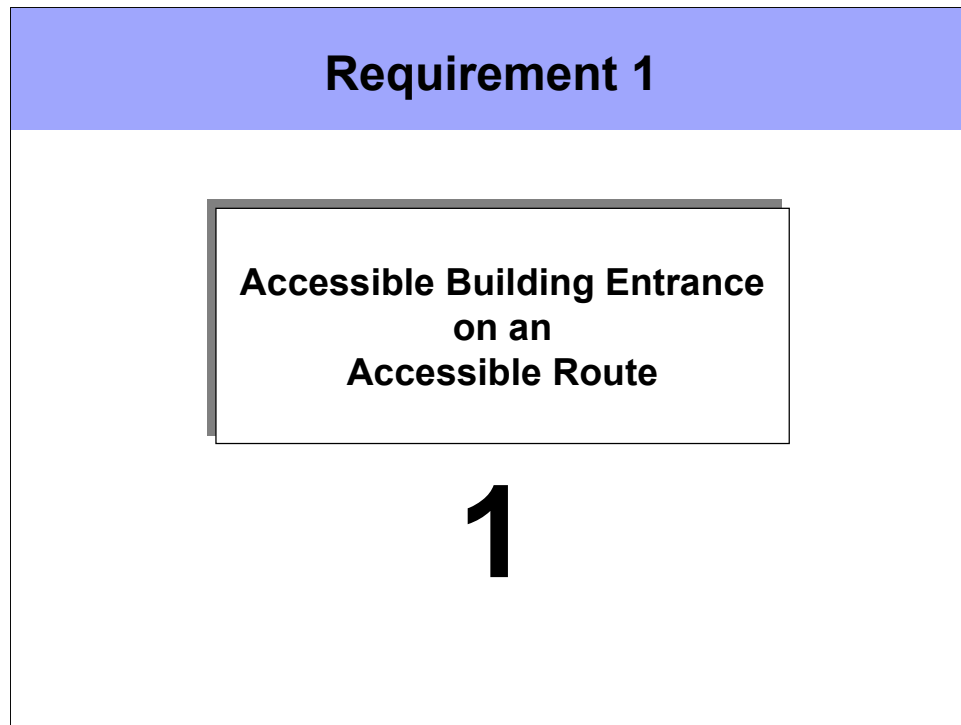

Requirement 1

Requirement 1 specifies that covered multifamily dwelling units must have at least one building entrance on an accessible route unless it is impractical to create an accessible route to the entrance.

The two acceptable causes for which impracticality can be claimed are:

1. Terrain (steep sites)
2. Unusual site characteristics (flood plains)

These will be discussed later in this session and in greater detail in other modules.

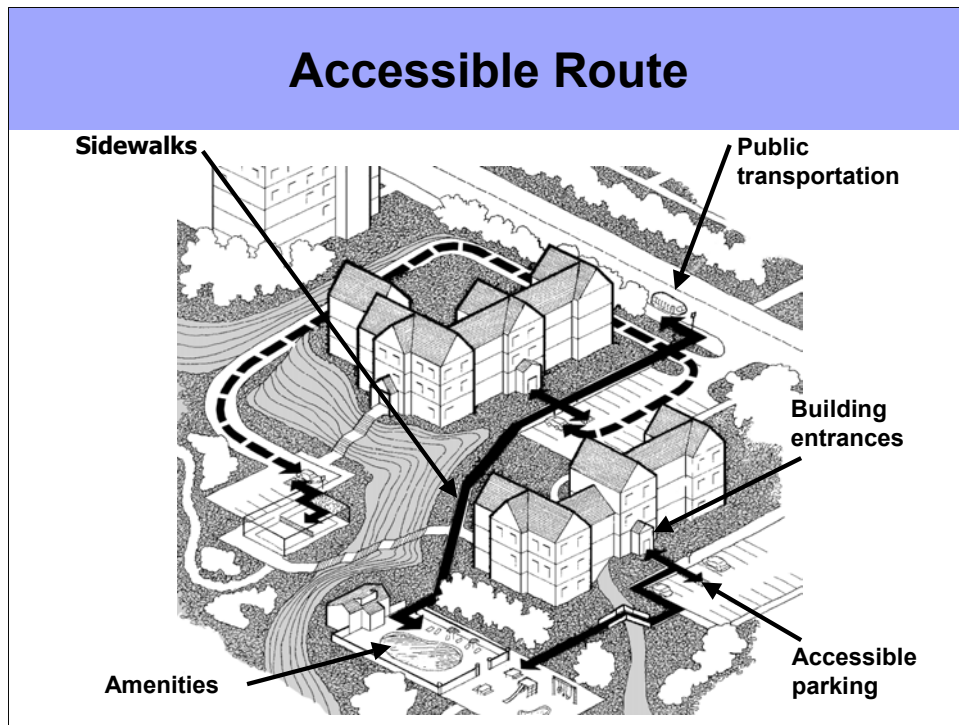

Accessible Route

Before discussing which building entrances are covered, it is important to understand the significance of an accessible route. An accessible route is the key element that allows people with mobility disabilities to travel around a building site and enter, use, and enjoy features available to all residents. It is a continuous pedestrian path with no steps, no abrupt changes in level and no steep slopes.

Accessible routes must be provided under Requirement 1, Accessible Building Entrance on an Accessible Route and Requirement 2, Accessible Public and Common Use Areas. Accessible routes in both Req. 1 and Req. 2 are a public and common use features and must comply with the technical specifications in Req. 2 which cites ANSI A117.1 (1986) (or a comparable standard) as the minimum standard for compliance.

Accessible routes must also be provided in Requirement 4, Accessible Route Into and Through the Unit. The technical specifications for accessible routes in Req. 4 are slightly less accessible and are provided within the text of the Guidelines. They will be discussed later in this module under Req. 4.

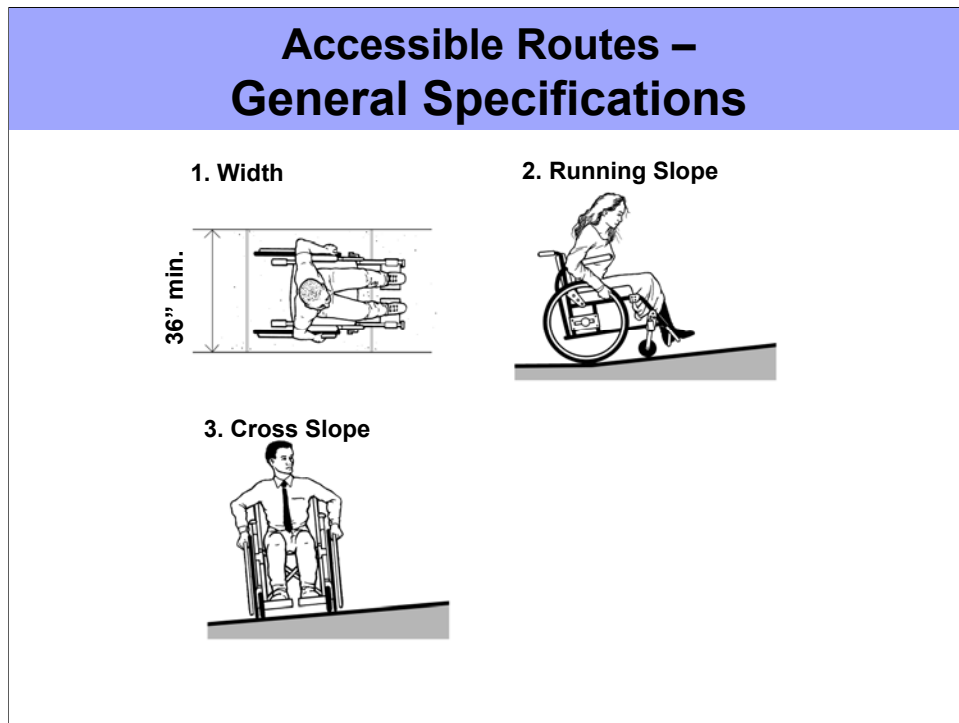

Accessible Routes - General Specifications

Specifications for accessible routes may be found in **ANSI 4.3, Accessible Route**. Some of the key specifications for an accessible route are:

1. A 36" minimum width. ANSI gives additional specifications to apply when accessible routes go around obstructions.
2. The maximum slope of an accessible route is 1:20. Slopes greater than 1:20, up to 1:12, are allowed, but they would have to comply with the ramp provisions in ANSI.
3. Cross slopes may not exceed 1:50 (approximately 1/4" per foot, which is 1:48).

Accessible Route (continued)

Accessible routes must be designed and constructed to comply with applicable sections of ANSI or a comparable standard. For instance, ANSI provides specifications for elements of an accessible route including:

- Width
- Slope
- Surface texture
- Passing space
- Head room
- Changes in level
- Absence of protruding objects

Now, we will discuss a few specifications for an accessible route.

1. Cross slopes on sidewalks must not exceed 1:50 (Approx. ¼" per foot). This limits a sidewalk from slanting from side to side. Too large a cross slope could cause a wheelchair user to lean too far to one side or the other or even cause a wheelchair to tip over. This standard helps prevent people on crutches from losing their balance.
2. Running slopes on walks must not exceed 1:20, a slope of 5%, unless the walk is designed as a ramp, in which case the maximum slope may be 1:12. Ramps must have railings on both sides of the ramp. In other words, if the walk is to go up one foot in height, it needs to be at least 20 feet long. People using wheelchairs cannot effectively use walks with steep slopes.
3. Required walks must be of a stable and firm material, not gravel or mulch.
4. Accessible routes must be designed for safe passage for persons using wheelchairs and for persons with other types of disabilities.

Where Accessible Routes are Required

- Accessible routes are required to connect covered dwelling entrances with:
 - Pedestrian arrival areas
 - Site facilities and amenities
 - Spaces and elements within a covered building

Where Accessible Routes are Required

Within the boundaries of a site, accessible routes are required to connect:

1. Covered dwelling entrances with pedestrian arrival areas (Req. 1 and 2). For instance, parking areas, public sidewalks and public transportation stops.
2. Covered dwelling entrances with site facilities and amenities (Req. 2). For instance, mail kiosks, laundry buildings, car wash facilities, recreation facilities, etc.
3. Covered dwelling entrances with spaces and elements within a covered building (Req. 2). For instance, corridors, trash chute rooms, fitness rooms, etc.

Accessible routes are not required to connect buildings that contain covered dwellings with other buildings that contain covered dwellings.

The wording in the Guidelines encourages the provision of accessible walks between buildings containing covered dwelling units when slopes are 1:12 or less. If such walks are provided, railings are not required.

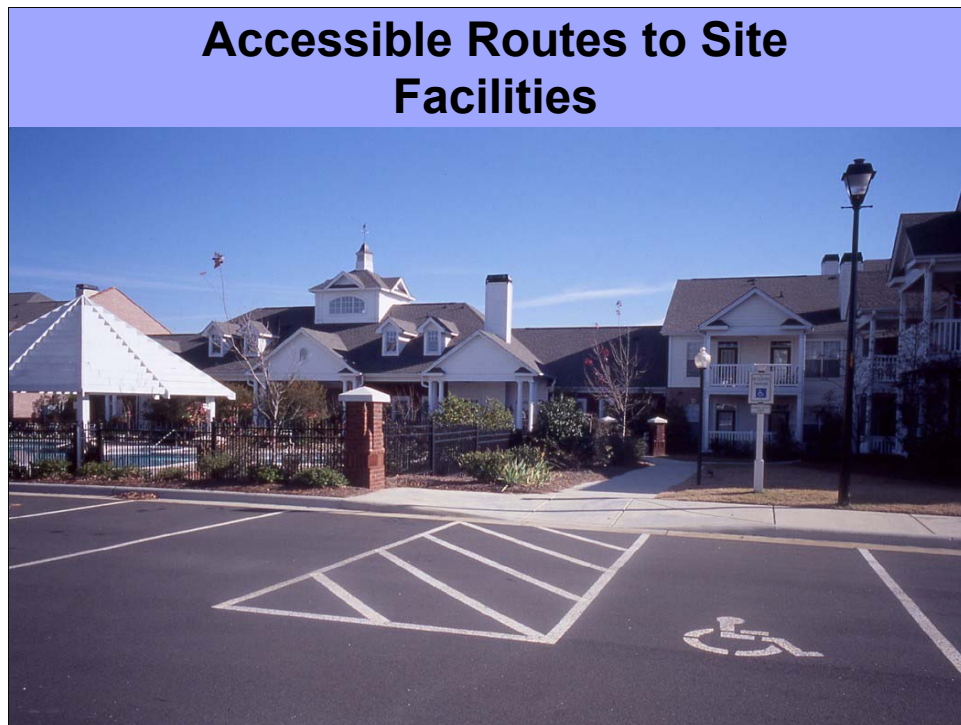

Accessible Routes to Site Facilities

Site amenities that are required to be on an accessible route include:

- mailbox kiosks
- separate laundry buildings
- clubhouses and pool areas
- manager's offices
- recreational areas
- refuse disposal areas

Public and common use areas will be discussed in more detail under Requirement 2, Accessible Public and Common Use Areas.

Routes from Buildings with Covered Units



Routes from Buildings with Covered Units

Accessible routes are not required to connect buildings that contain only covered units with other buildings that also only contain covered units.

Language in the Guidelines encourages accessible walks to be provided between these buildings if the slope of the walk is 1:12 or less. If walks connect buildings containing only covered units, then railings are not required along the walks.

However, the walk between buildings must be accessible if it is a route to a building that has both covered units and a common use facility.

Accessible Routes Within Buildings Containing Covered Units



Accessible Routes Within Buildings Containing Covered Units

Within a building containing covered dwelling units, common use areas must be accessible and they must be on an accessible route.

Examples of common use areas include:

- mailrooms
- club houses and other entertainment areas
- trash chutes
- observation decks
- laundry rooms
- terraces, including those located on rooftops
- swimming pools
- fitness rooms
- office centers

Elements of an Accessible Route

- Sidewalks
- Curb-ramps
- Access aisles
- Ramps
- Lifts
- Elevators
- Elevated walkways

Elements of an Accessible Route

Elements of an accessible route could include:

- sidewalks
- curb-ramps
- access aisles that provide access to parking spaces
- ramps
- lifts
- elevators
- elevated walkways

Level Elevated Walkways



Level Elevated Walkways

A level elevated walkway is an effective and attractive solution to connect uphill pedestrian arrival areas with ground floors of covered buildings.

Notes:

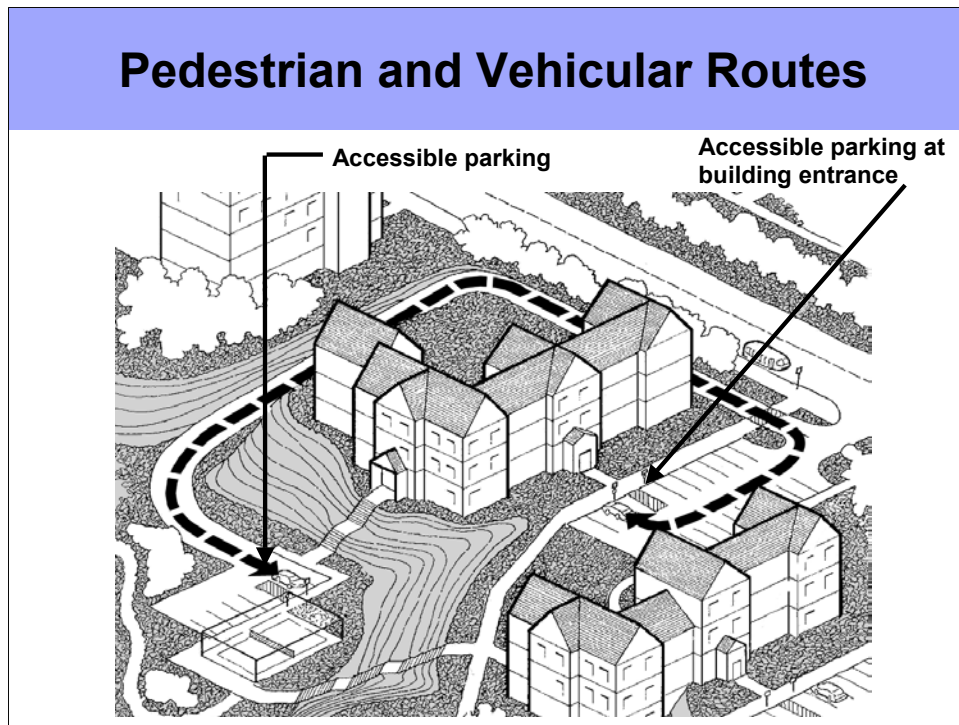

Pedestrian and Vehicular Routes

Ideally, people with disabilities should be able to travel throughout the complex by means of an accessible pedestrian route. However, there may be situations in which an accessible pedestrian route is not practical because of factors beyond the control of the owner.

On such sites, the Guidelines allow for access via a vehicular route in lieu of an accessible pedestrian route. This means it may be necessary for a person with a disability to drive from building to building to reach public and common use spaces.

This is permissible only if factors beyond the control of the owner result in (1) a finished grade exceeding 8.33%, (2) natural or manmade physical barriers, or (3) legal restrictions, any of which prevents the installation of an accessible pedestrian route.

On sites that meet the above conditions for provision of access by a vehicular route, there must be accessible parking spaces and curb cuts provided at each facility or amenity that cannot otherwise be reached on an accessible pedestrian route.

Covered Buildings Entrances

1. Buildings with common entrances
2. Buildings with separate covered entrances
3. Buildings with clusters of dwellings
4. Buildings with elevators

Covered Building Entrances

1. Buildings with one or more common entrances must have at least one accessible entrance that leads to all the ground floor dwelling units.
2. In buildings containing ground floor dwelling units that have their own exterior entrance, each individual dwelling entrance must be accessible.
3. In buildings with multiple entrances, where each entrance serves a cluster of dwellings, each entrance serving a cluster must be accessible.
4. Buildings with elevators that have one or more common entrances must have at least one accessible entrance.

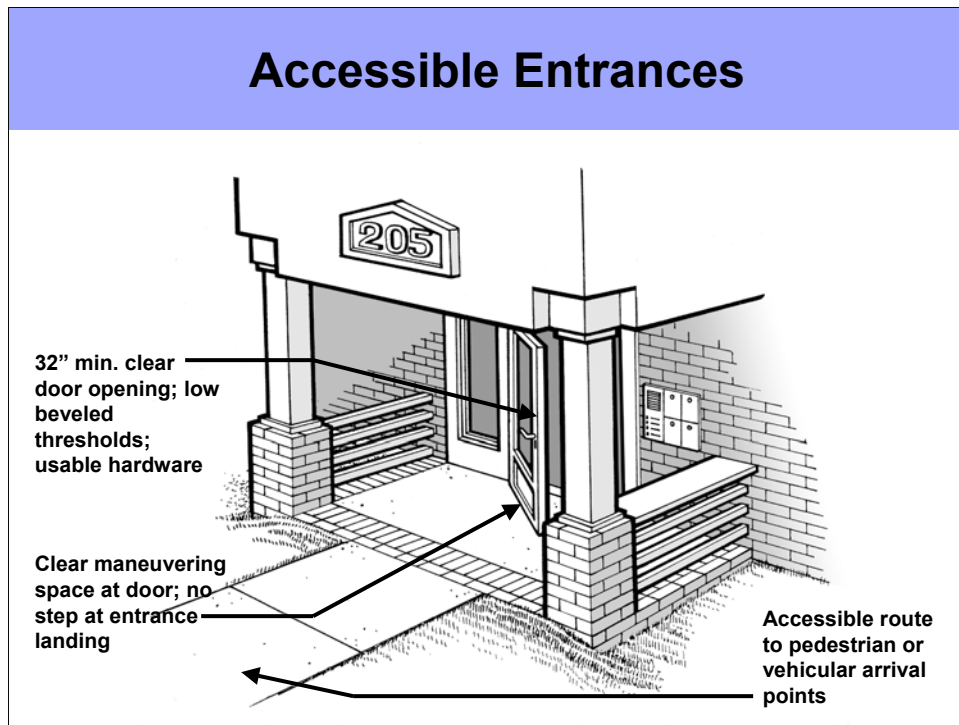

Accessible Entrances

Entrances required to be accessible must be usable by people with disabilities. Detailed specification to achieve this are found in applicable sections of ANSI 4.13 – Doors.

When dwellings have individual separate entries, only the common use exterior side of the unit entrance must comply with ANSI. However, on common building entrances, both sides of the entrance door must meet applicable ANSI specifications.

Some of the key features specified in ANSI 4.13 include:

- 32-inch minimum clear opening. ANSI 4.13.5
- Clear maneuvering space at doors. ANSI 4.13.6
- 1/2" maximum height thresholds beveled 1:2 or less (for swinging doors). ANSI 4.13.8
- Usable door hardware that can be used without tight grasping, pinching, or twisting. ANSI 4.13.9
- Safe door closing speed when door closures are used. ANSI 4.13.10

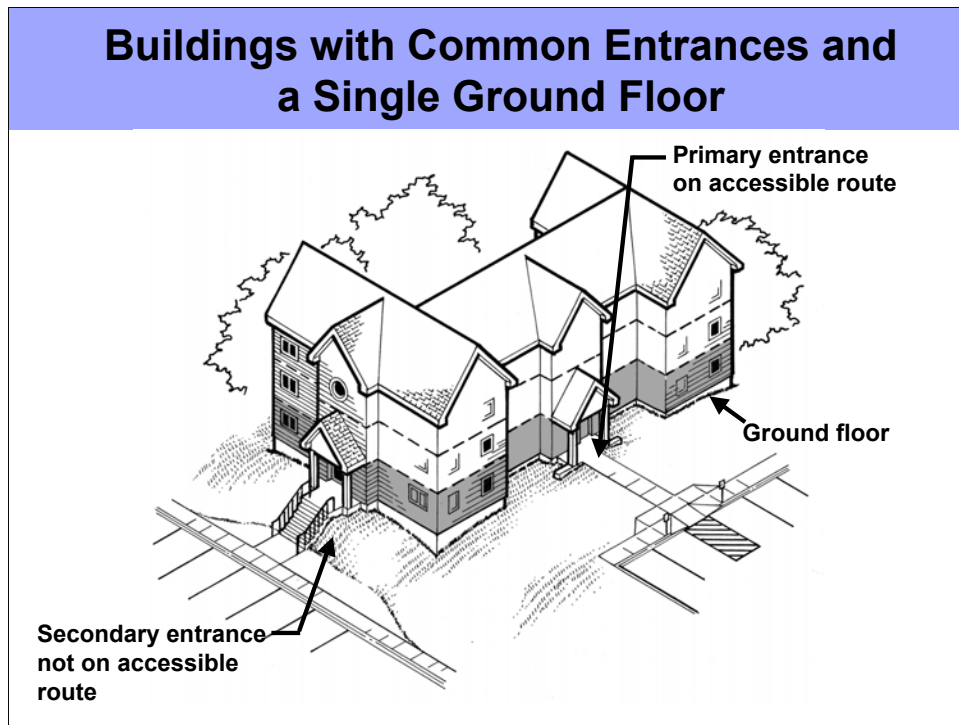

Buildings with Common Entrances and a Single Ground Floor

When a building has more than one common entrance but only one ground floor, at least one of the entrances must be accessible. It must be the main or primary entrance and be on an accessible route connecting all ground floor units.

The accessible route must connect the building entrance to a pedestrian arrival point. If the pedestrian arrival point is a parking lot, as shown in this example, the accessible route must connect the parking space and access aisle with the building entrance.

Notes:

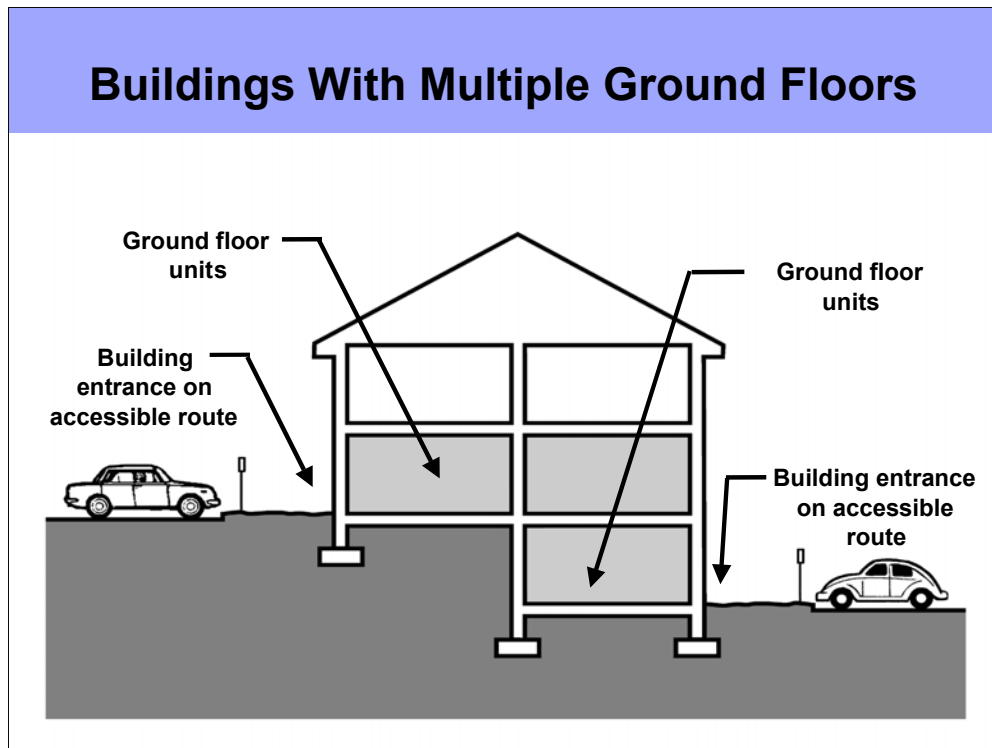

Buildings With Multiple Ground Floors

There are numerous building configurations that could have more than one ground floor. When vehicular arrival points are established at the entrance to a building, the level of the building served by that entrance is considered to be a ground floor.

The Guidelines define a ground floor as "A floor of a building with a building entrance on an accessible route. A building may have one or more ground floors."

Notes:

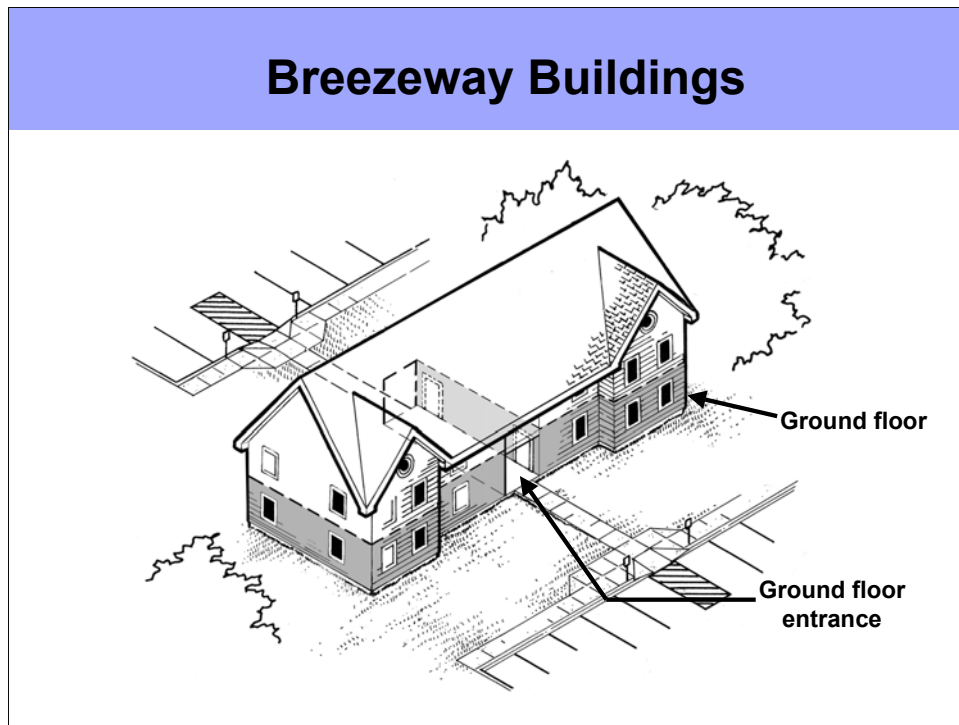

Breezeway Buildings

Breezeway buildings may be thought of as buildings with a common entrance, except that the entrance and the interior corridor are open to the elements.

Like buildings with common entrances, each breezeway entrance serving a cluster of covered dwellings must be accessible. And like buildings with common entrances, when a breezeway serving a cluster of covered dwellings has more than one entrance, at least one has to be accessible.

Notes:

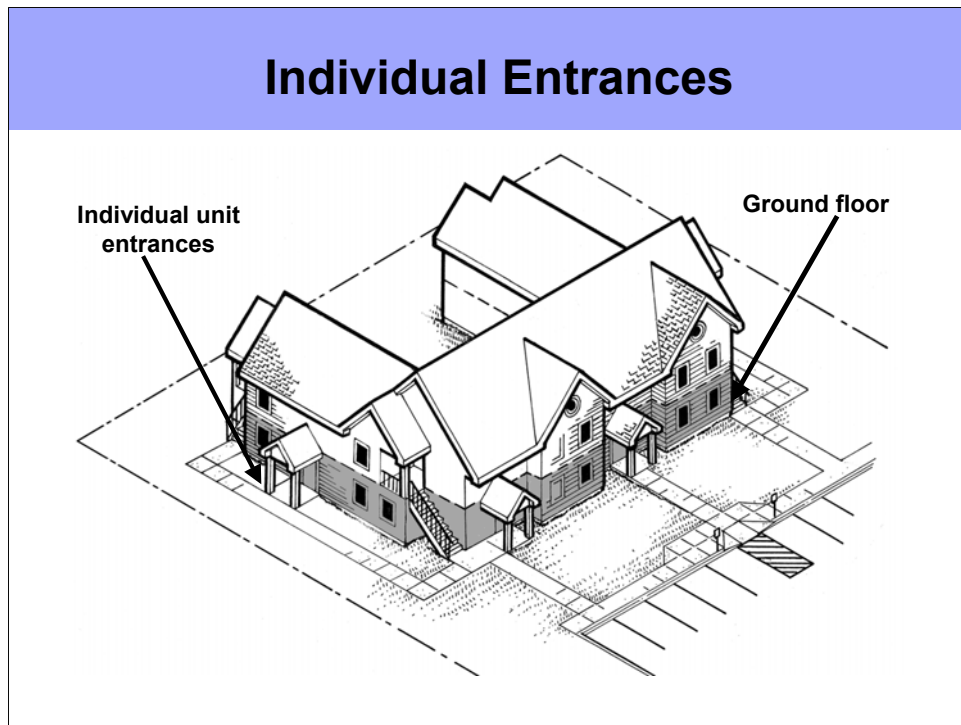

Individual Entrances

When a building has ground floor units, each with its own exterior entrance, then each of these ground floor units must have an accessible entrance on an accessible route.

Notes:

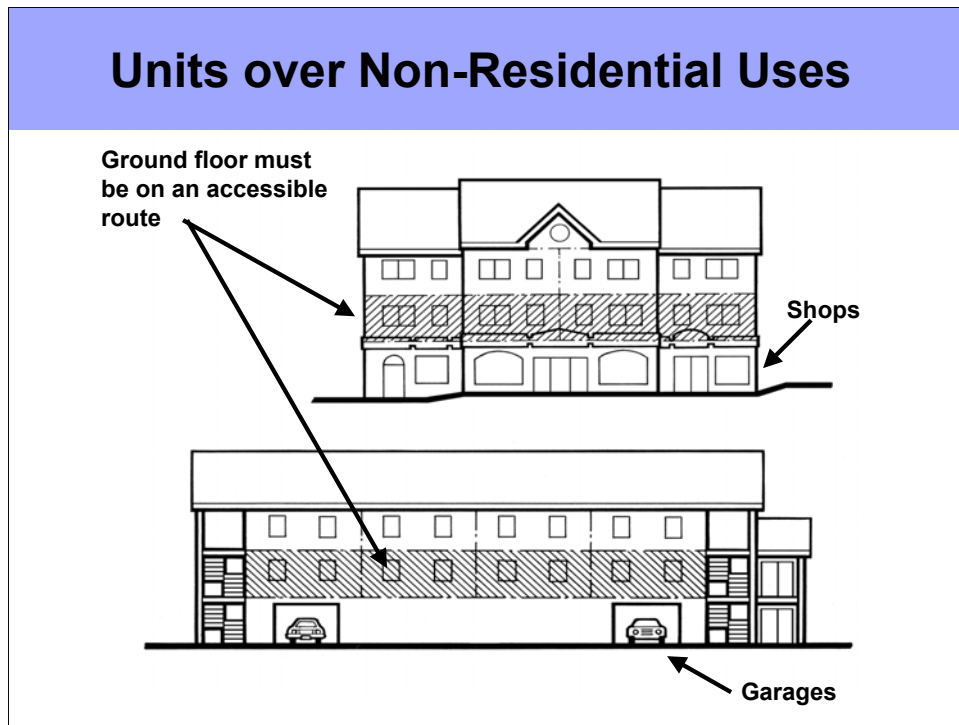

Units over Non-Residential Uses

In the definition section of the Guidelines, "ground floor" is defined as a floor of a building with a building entrance on an accessible route. The definition also states that when the first floor containing covered dwelling units in a building is above grade, all units on that floor must be served by a building entrance on an accessible route.

Single story units located over a common garage or other non-residential use, such as retail shops, must be on an accessible route. Most buildings of this type incorporate an elevator to provide an accessible route. The elevator, in this case, could stop at the first level containing dwelling units. If the elevator extends to the higher floors, then all units in the building are covered and the elevator must serve all floors.



Unusual Site Terrain

In rare instances, some units may not be covered by the Guidelines because they are built on steeply sloping sites or sites with other unusual characteristics. The Guidelines provide tests to determine site impracticality—two for steep terrain and one for unusual characteristics such as flood plains or coastal high hazard areas.

The tests provided in the Guidelines are intended to be applied during the early phases of design. Claims of site impracticality should always be substantiated by evidence tabulated during the application of the appropriate test.

Notes:

Site Impracticality Tests – Terrain

- Two tests are used to determine if a site is impractical due to steep terrain:
 1. Individual Building Test
 2. Site Analysis Test

Site Impracticality Tests – Terrain

The two tests for determining site impracticality due to steep or difficult terrain are:

1. The Individual Building Test: a test which analyzes the grade difference between planned building entrances and pedestrian arrival points.
2. The Site Analysis Test: a test which analyzes the site as a whole to establish minimum numbers of units that must be made accessible.

Both tests will be discussed in more detail later in this presentation. Determination of which test to apply depends upon the type and number of buildings planned for a site.

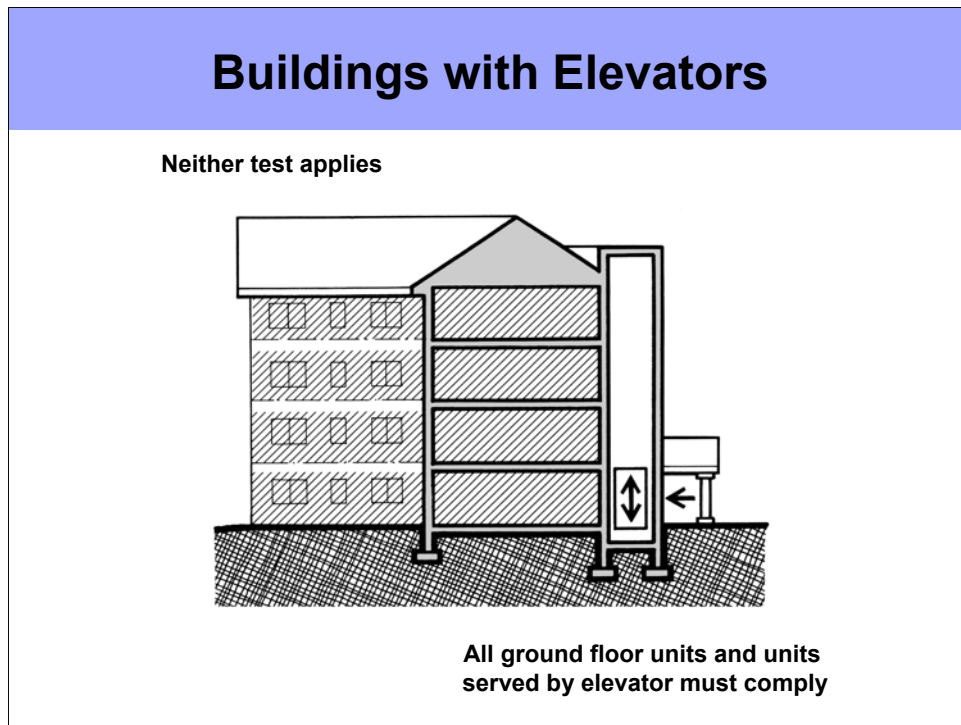

Buildings with Elevators

For buildings with elevators, neither test can be used. At least one entrance must be accessible. All ground-floor units served by that entrance, as well as all units on floors served by the elevator, must meet the Guidelines.

Notes:

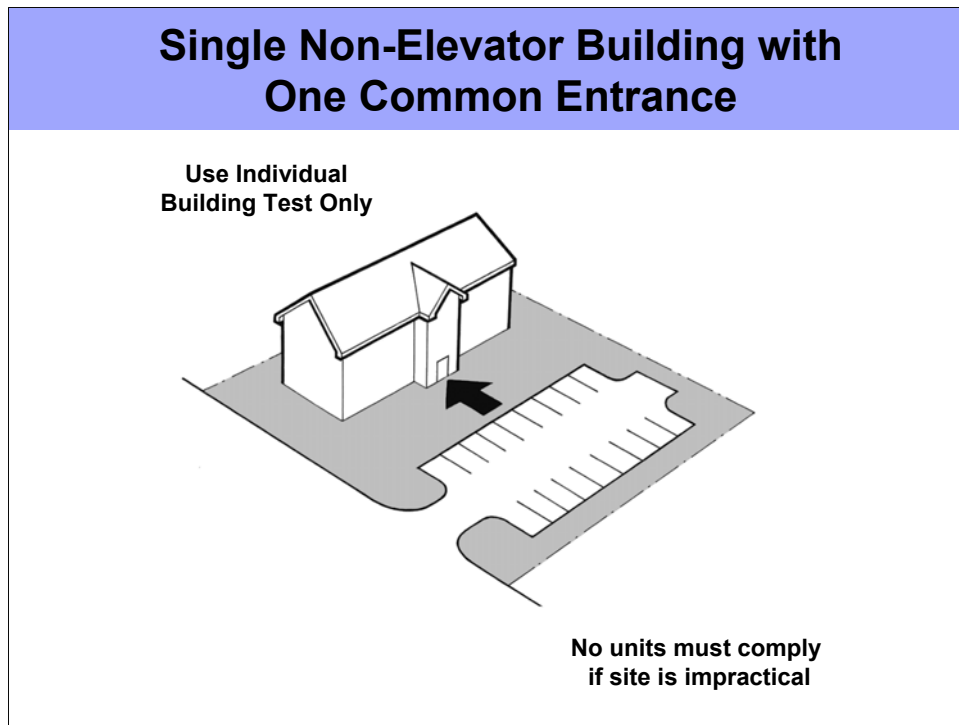

Single Non-Elevator Building with One Common Entrance

A site with just one non-elevator building, having only one common entrance into the building, may only be analyzed using the Individual Building Test.

If the site is found impractical, no units are covered.

Notes:

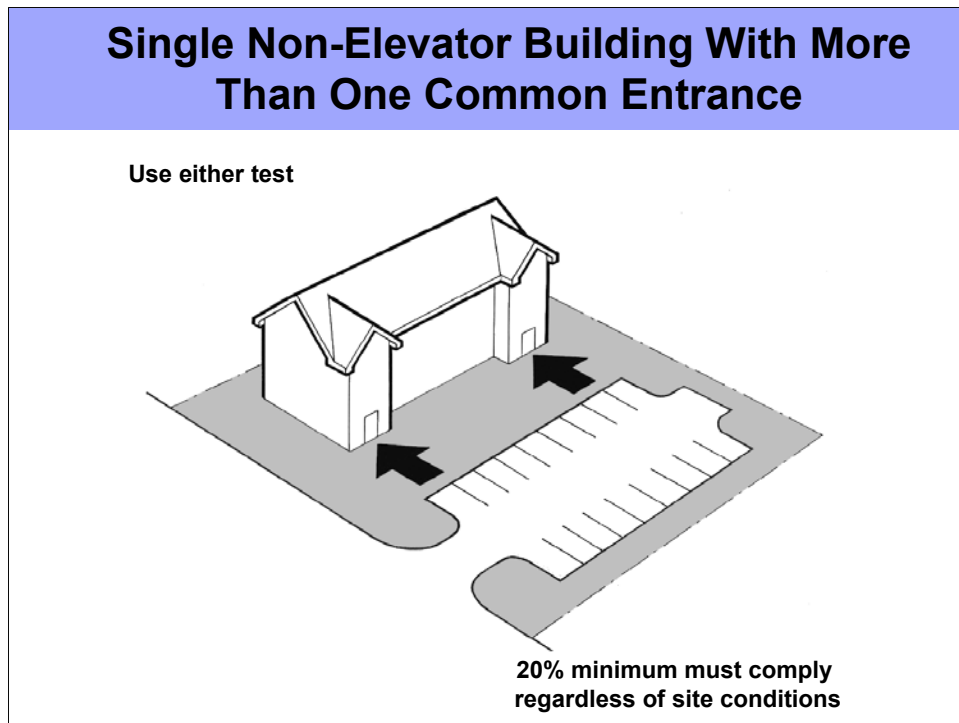

Single Non-Elevator Building With More Than One Common Entrance

A site with only one non-elevator building, but with more than one common entrance, may be analyzed using either the Individual Building Test or the Site Analysis Test.

Regardless of which test is used, a minimum of 20% of the planned ground floor units must be on an accessible route and meet the Guidelines. This 20% is a starting point. After the test is applied, in most cases you will find that more units must comply.

Notes:

Multiple Non-Elevator Buildings Each With More Than One Entrance

Use either test

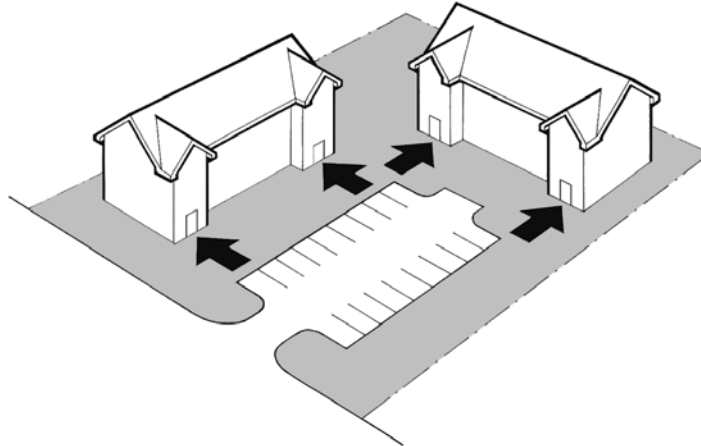

20% minimum must comply regardless of site conditions

Multiple Non-Elevator Buildings Each With More Than One Entrance

A site with several non-elevator buildings, but each with more than one entrance, may also be analyzed using either test. Again, regardless of which test is used, the minimum 20% of the planned ground floor units must be on an accessible route and meet the Guidelines. The 20% is a starting point. After the tests are applied, in most cases, you will find that more units must comply.

Notes:

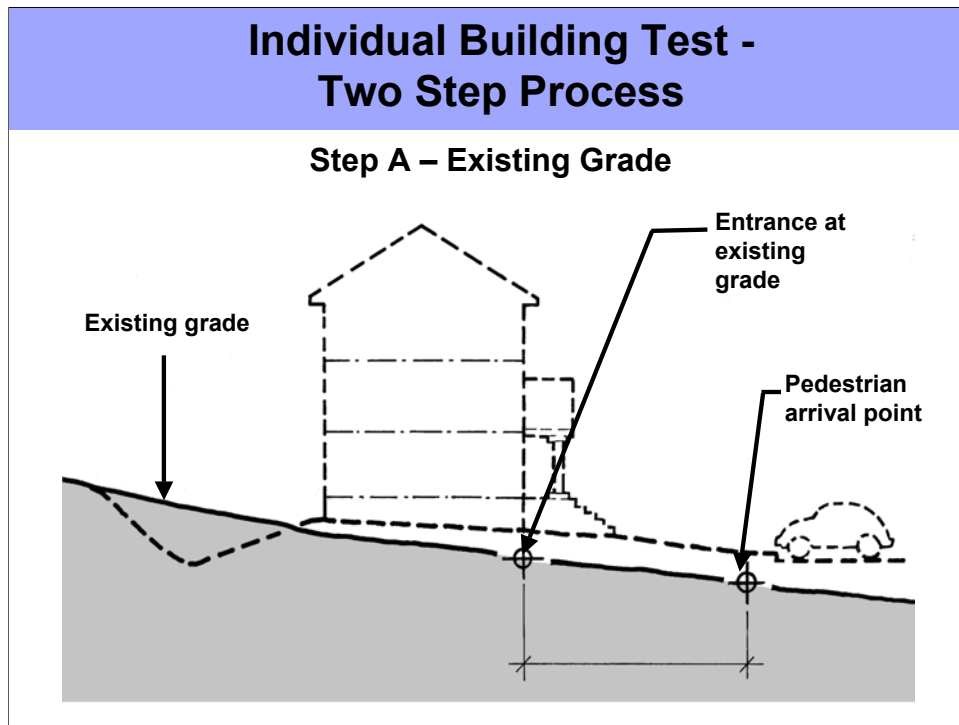

**Individual Building Test –
Two Step Process**

Using the Individual Building Test is a two-step process:

In step A, the slope of the existing grade elevation must be made from the center of the **planned** entrance or door to all pedestrian arrival points within 50 feet. If the slope exceeds 10%, proceed to step two.

Notes:

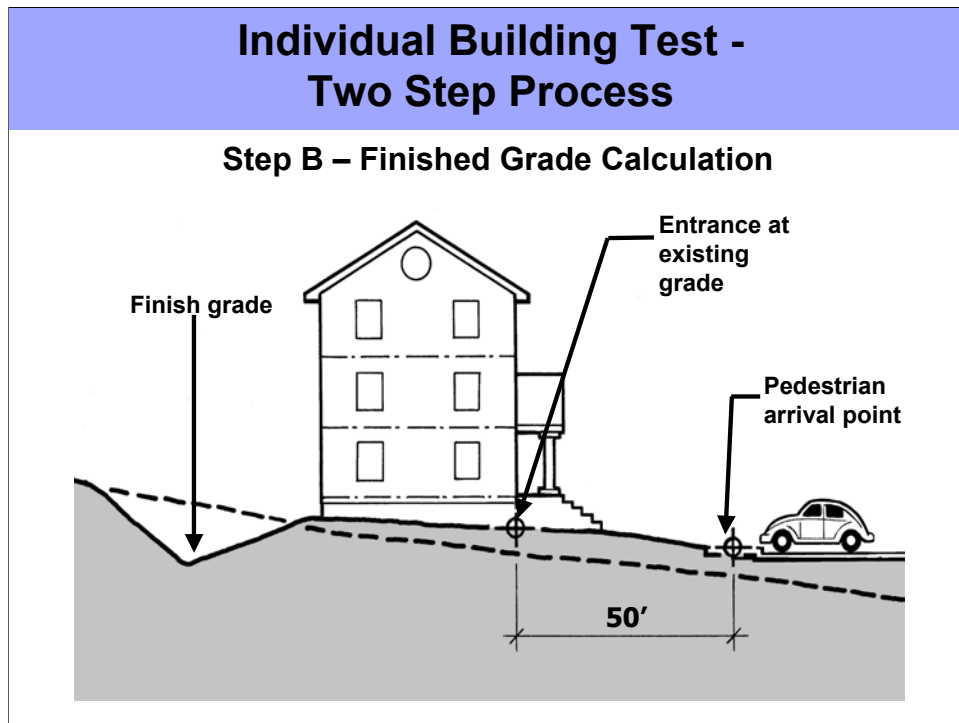

Individual Building Test - Two Step Process

In step B, the slope calculation must be made from the center of the planned entrance at planned finished grade elevation to all pedestrian arrival points within 50 feet. At this point in the design process, finish floor elevations established for the sake of preparing a grading plan should be considered preliminary.

If the slope in step B also exceeds 10%, the entrance could be exempt and designers can set finish floor elevations at whatever height they want.

Notes:

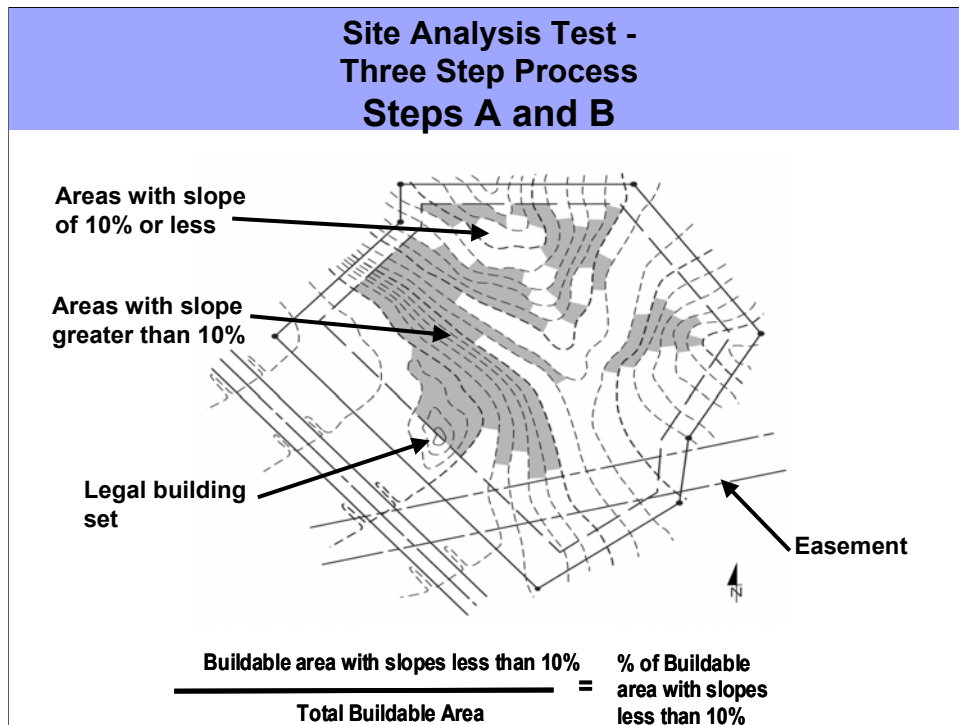

Site Analysis Test – Three Step Process Steps A and B

The Site Analysis Test is a three-step test which requires a pre-design analysis of the entire site to determine a minimum number of units that must be on an accessible route and meet the other accessibility requirements in the Guidelines.

Step A: A topographic survey of the site is prepared and the total “buildable area,” with slopes less than 10%, is calculated. The percentage of total buildable area with slopes less than 10% is calculated by dividing the total buildable area by the buildable area with slopes less than 10%.

Buildable area is that portion of the site where buildings may legally be built – excluding non-buildable areas such as building set back areas, utility easements, etc.

The Guidelines specify that the topographic survey shall show elevation contours at two foot intervals.

**Site Analysis Test – Three Step Process
Steps A and B**

Step B: The minimum number of ground floor units that must meet the Guidelines is determined.

The minimum number of ground floor units that must be made accessible must equal the percentage of buildable area with slopes less than 10% calculated in Step A. The accuracy of the slope analysis, steps A and B, must be certified by a professional surveyor, engineer, or other qualified professional.

This is only a minimum threshold, more units may be required to be accessible. This determination is made in the following Step C.

Notes:

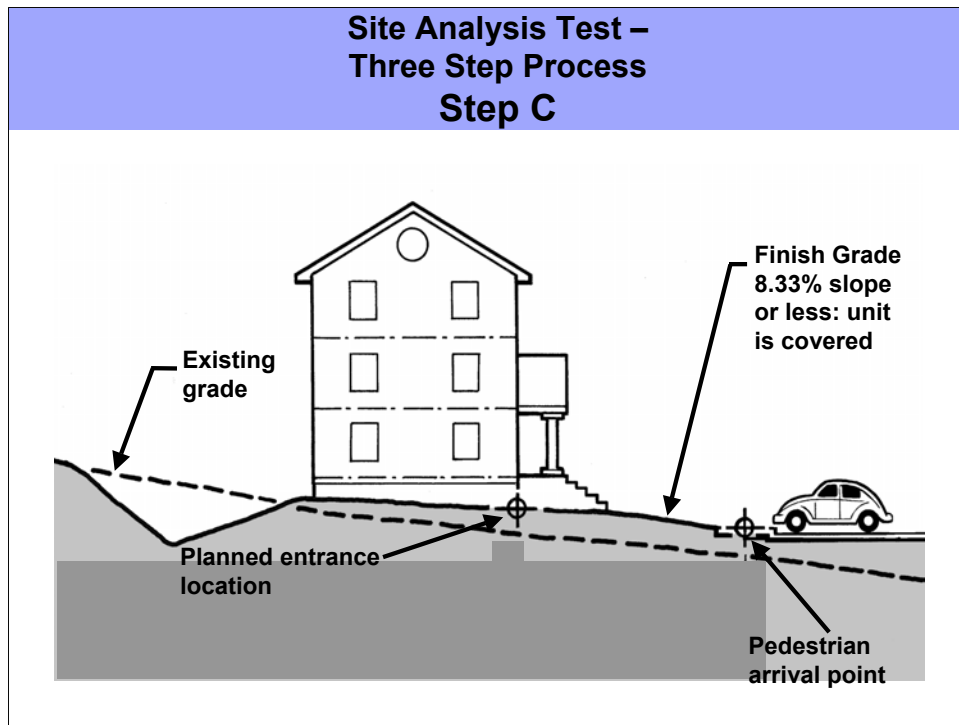

Site Analysis Test – Three Step Process Step C

Step C: Designers must review the site plan again during the design process to determine if additional units must be added to the minimum number established in Step B.

A preliminary site plan must be prepared with the minimum number of units designated.

The grade differences are then calculated at the remaining units between the planned entrance and the pedestrian arrival point.

If the grade is 8.33% (1:12) or less, then those units must be added to the minimum number of covered units.

Site Impracticality Due to Unusual Characteristics

Examples:

- Federally Designed Flood Plains
- Coastal High Hazard Areas



Site Impracticality Due to Unusual Site Characteristics

It may be impractical to provide an accessible route on certain sites where a law or regulation requires the lowest finish floor or other structural member to be raised to a specific level above the base floor evaluation.

Examples of such sites are those located in federally designated flood-plains or coastal high-hazard areas, where buildings must be raised to a specific level above the base flood elevation.

Notes:

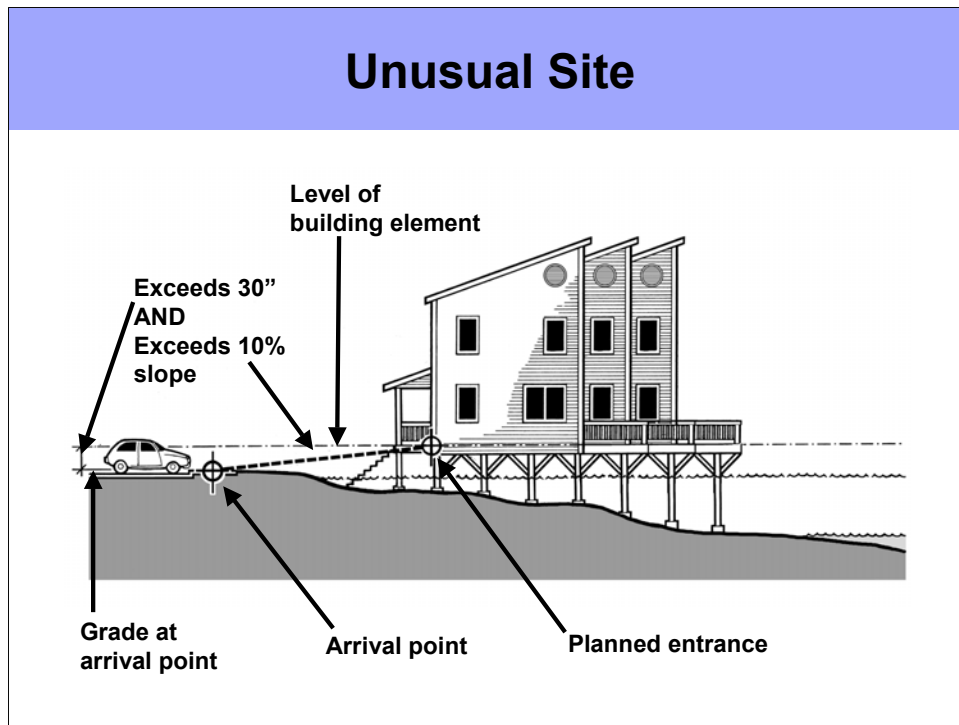

Unusual Site

On a site with unusual characteristics, it is impractical to provide an accessible route to a building entrance only if both of the following conditions occur:

1. There is a 30'' difference in finished grade elevation measured between the lowest permissible planned entrance and all pedestrian arrival points within 50'. If there are no pedestrian arrival points within 50' of the planned entrance, the measurement must be made between the lowest allowed planned entrance and the closest pedestrian arrival point, **AND**
2. The slope between the the lowest permissible planned entrance and all pedestrian arrival point within 50' exceeds 10%. Likewise, if there are no pedestrian arrival points within 50' of the planned entrance, the measurement must be made between the lowest allowed planned entrance and the closest pedestrian arrival point.

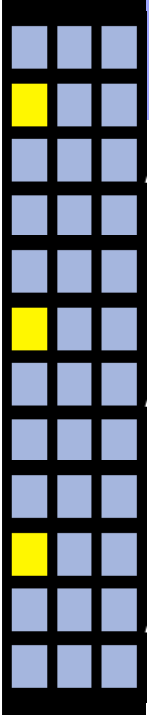

Technical Overview - Agenda

- Overview of the Fair Housing Act
- Technical Requirements of the Fair Housing Act
 - Requirement 1
 - **Requirement 2**
 - Requirement 3
 - Requirement 4
 - Requirement 5
 - Requirement 6
 - Requirement 7
- Strategies for Compliance
- Resources

Notes:

Requirement 2

**Accessible and Usable
Public and Common Use
Areas**

2

Requirement 2

Requirement 2 specifies that public and common use areas be accessible to people with disabilities, permitting them access to and use of amenities.

Notes:

ANSI Standard

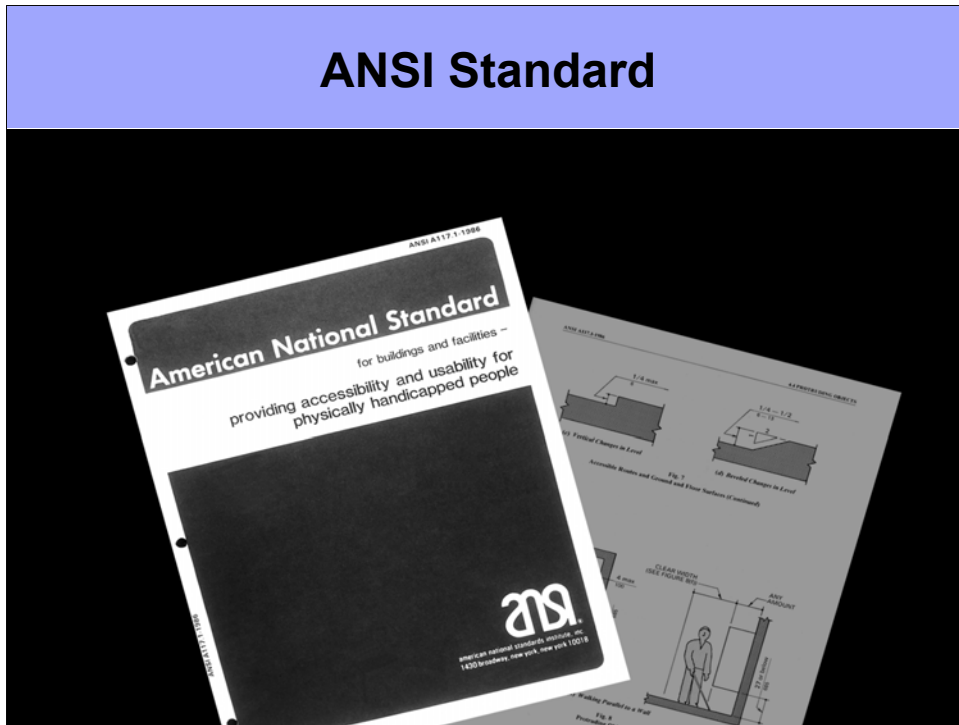

ANSI Standard

The Guidelines reference the 1986 ANSI (American National Standards Institute) A117.1 Standard as the set of technical specifications to follow when designing accessible public and common use areas. Other accessibility standards may be followed, but they must be as accessible as the ANSI Standard.

While minimal levels of accessibility are specified in the Guidelines for dwelling interiors (Requirements 3 – 7), high levels of accessibility are achieved in the public and common use areas due to the application of ANSI. This makes sense, because public and common use areas are most likely to serve people with disabilities.

HUD also recognizes CABO/ANSI-1992 and ICC/ANSI-1998 as acceptable standards, for the technical criteria, in terms of meeting minimum compliance with Requirement 2.

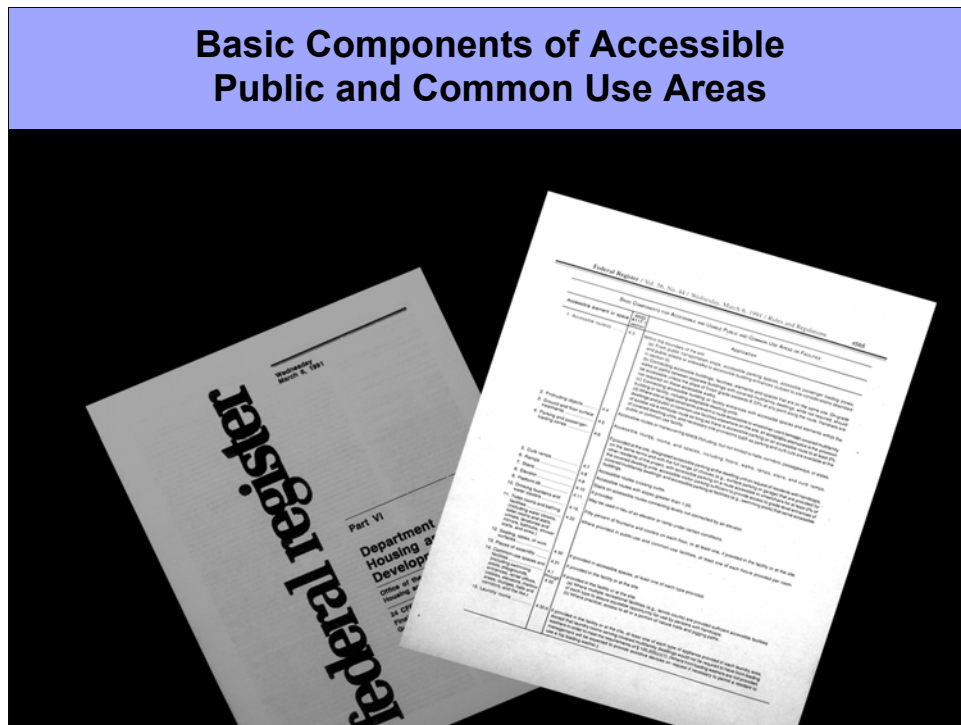

Basic Components of Accessible Public and Common Use Areas

The Guidelines include a chart that identifies public and common use elements and spaces that must be accessible. The chart references the applicable section of the ANSI Standard and gives further directions on where, when, and how many elements and spaces must be accessible.

Generally the public and common use areas must be on an accessible route so they can be approached, entered, and used by people with disabilities.

Notes:

Minimum Parking Requirements

- For Residents
 - 2% of parking spaces serving covered dwelling units
 - A minimum of one accessible space at each site facility

- For Visitors (if provided)
 - A sufficient number of spaces to provide access to grade level entrances of covered multifamily dwellings
 - A minimum of one at sales/rental office

Minimum Parking Requirements

In the provisions of Requirement 2 in the Guidelines, minimal levels of accessible parking are established.

For residents:

- 2% of parking spaces serving covered dwelling units and upon request by persons with disabilities
- A minimum of one accessible space at each site facility where parking is provided, such as swimming pool, mail kiosk, clubhouse, recreation facilities, etc.

For visitors (if visitor parking is provided):

- A sufficient number of spaces to provide access to grade level entrances of covered multifamily dwellings
- A minimum of one at sales/rental office

A sufficient number can be established by examining the total number of visitor parking provided compared to the total size of a project. A one-space minimum is required, but more should be provided if a large amount of visitor parking has been provided for the benefit of residents.

Parking Facilities

- Parking facilities must be accessible, including:
 - Car ports
 - Detached garages
 - Covered parking within buildings containing units



At least one of each must be made accessible

Parking Facilities

When a development provides different types of parking such as car ports, detached garages, covered parking within buildings containing dwelling units, etc., accessible parking must be provided on the same terms and range of choices that are offered other residents. At least one of each type must be made accessible.

At facilities, such as a leasing office, where other laws such as ADA may apply, accessible van parking may be required.

Notes:



Accessible Parking Space

The minimum specification in the ANSI Standard for an accessible parking space is a 96" wide parking space and a 60" access aisle. The width of the space and the access aisle help ensure that people using the space have enough room to unload a wheelchair and get out of a vehicle safely.

Accessible parking spaces serving a public leasing office or other facility open to the public located within a multifamily project may also be subject to the ADA. In these cases, van accessible parking is required which would have a 96" access aisle. The complete standard for a van accessible parking space can be found in ADAAG.

Notes:

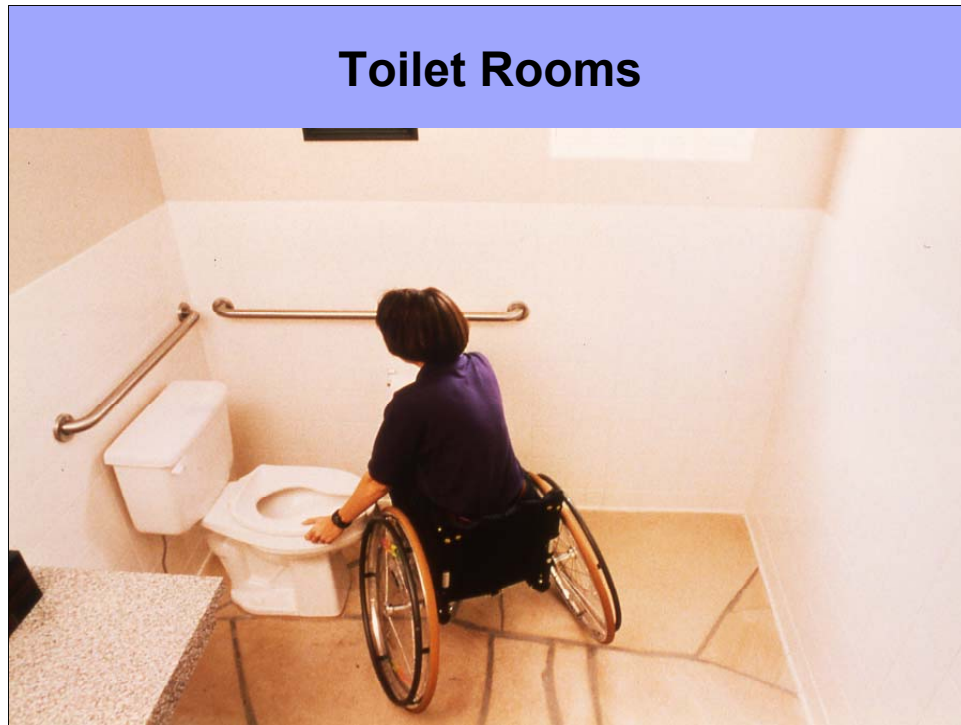

Toilet Rooms

When there is a toilet room in a public area, it must meet all of the applicable sections of the ANSI Standard, including providing compliant maneuvering space and grab bars.

Notes:

Specifications for Sinks



Specifications for Sinks

Sinks in public toilet rooms must have knee space, pipe protection, and usable faucet handles, such as lever style. Mirrors must be mounted at a usable height and paper towel dispensers must be within reach ranges specified in ANSI.

Notes:

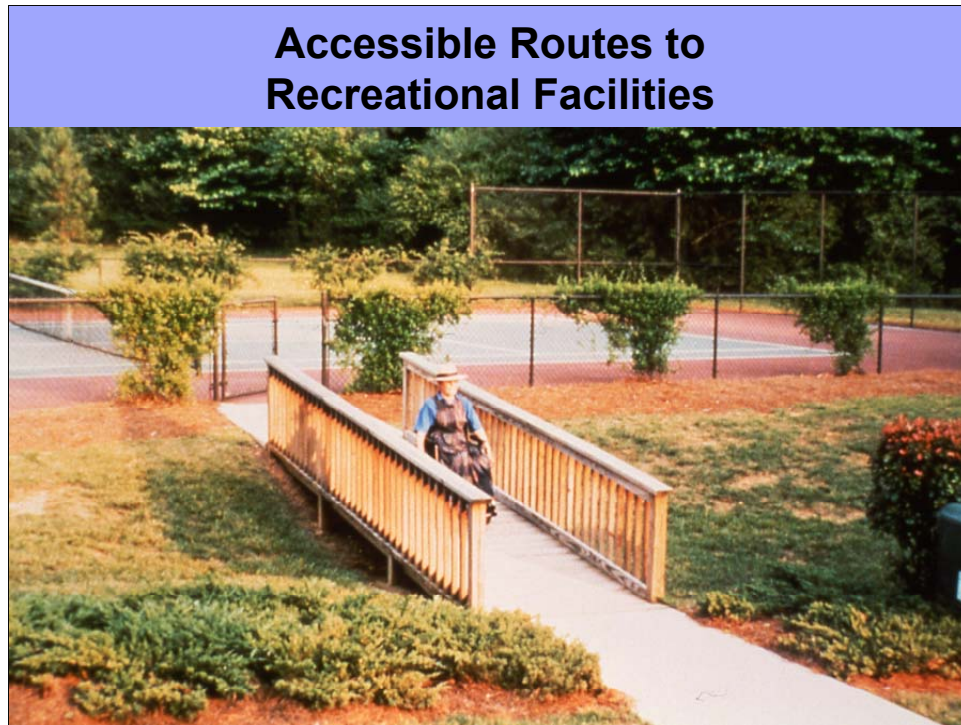

Accessible Routes to Recreational Facilities

When multiple amenities, such as tennis courts, playgrounds or spas are provided within the same development, the Guidelines stipulate that not all, but a “sufficient” number of each type must be accessible.

The number determined to be sufficient must ensure an equitable opportunity for use by people with disabilities. It is recommended that all recreational facilities be accessible when the site is relatively flat and this can be easily achieved.

Notes:

Accessible Recreational Facilities



Accessible Recreational Facilities

When there is a swimming pool, access must be provided to the pool area. The Guidelines do not require an accessible route (ramp or lift) down into the water at pools.

Presently the U.S. Access Board is in the process of publishing standards for access into pools. HUD is considering adopting such standards when they are published.

Notes:

Accessible Recreational Areas



Accessible Recreational Areas

The routes and areas around recreation, craft or lounge areas must be accessible. When there are tables, counters or work surfaces, one of each type must be accessible and have knee space.

Notes:

Accessible Drinking Fountains



Accessible Drinking Fountains

If drinking fountains are provided, at least 50% must be accessible, with knee space and other features specified in ANSI.

Accessible Laundry Facilities



Accessible Laundry Facilities

Laundry facilities must be on an accessible route. Although front-loading washing machines are not required, adequate maneuvering space must be provided so a person who uses a wheelchair can approach and pull up close to the machine.

However, upon request, management must provide mechanical reachers so a seated person can reach into a top-loading machine.

Notes:

Accessible Mailboxes



Accessible Mailboxes

Mailboxes must be within reach ranges established in ANSI, although normally not all of the mailboxes provided serve covered dwellings, it is recommended that all the mailboxes be placed within reach range; no higher than 54" for a side reach, or 48" for a forward reach, and no lower than 9" for a side reach and 15" for a forward reach.

This will ensure that regardless of the installed mailbox system, or established numbering system, mailboxes serving ground floor dwellings will be accessible.

Notes:

Accessible Trash Facilities



Accessible Trash Facilities

Trash dumpsters are a common use facility, and a sufficient number on the site must be on an accessible route. In the project depicted above, although not required, all the dumpsters have been recessed into the ground and equipped with lightweight, easy-lift lids. Such solutions use standard products and devices in innovative ways and benefit the community as a whole.

If enclosures are built around dumpsters, these must be an accessible entrance into the enclosure leading to the door of the dumpster.

Notes:

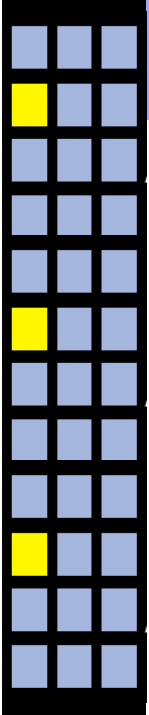

Technical Overview - Agenda

- Overview of the Fair Housing Act
- Technical Requirements of the Fair Housing Act
 - Requirement 1
 - Requirement 2
 - **Requirement 3**
 - Requirement 4
 - Requirement 5
 - Requirement 6
 - Requirement 7
- Strategies for Compliance
- Resources

Notes:

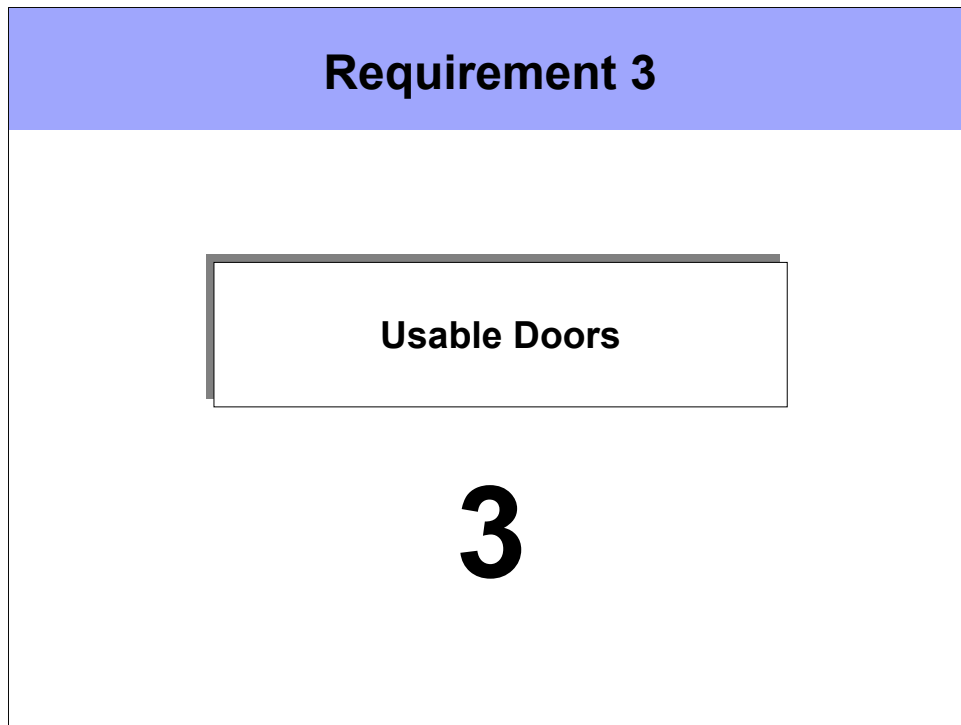

Requirement 3

Requirement 3 specifies that all passage doors in covered buildings be wide enough to provide access for people who use wheelchairs. The Guidelines distinguish between doors in public and common use areas and doors within individual dwelling units.

Notes:

Specifications for Doors in Public and Common Use Areas

- Must be fully accessible
- Must meet the specifications of ANSI 4.13
- Features:
 - Width
 - Maneuvering Clearances
 - Thresholds
 - Hardware
 - Opening Force

Specifications of Doors in Public and Common Use Areas

Doors in public and common use areas must be fully accessible and meet the applicable sections of ANSI or comparable standard.

Features of accessible doors include:

- clear width
- maneuvering clearances for approach
- thresholds
- hardware
- opening force

Notes:

32-Inch Clear Opening



32-inch Clear Opening

Doors in common use areas must provide a minimum of a 32" clear opening.

The doors must also provide hardware that does not require tight grasping or twisting.

Interior doors must not require more than 5 pounds of force to operate; if so, it must be automatic.

Notes:

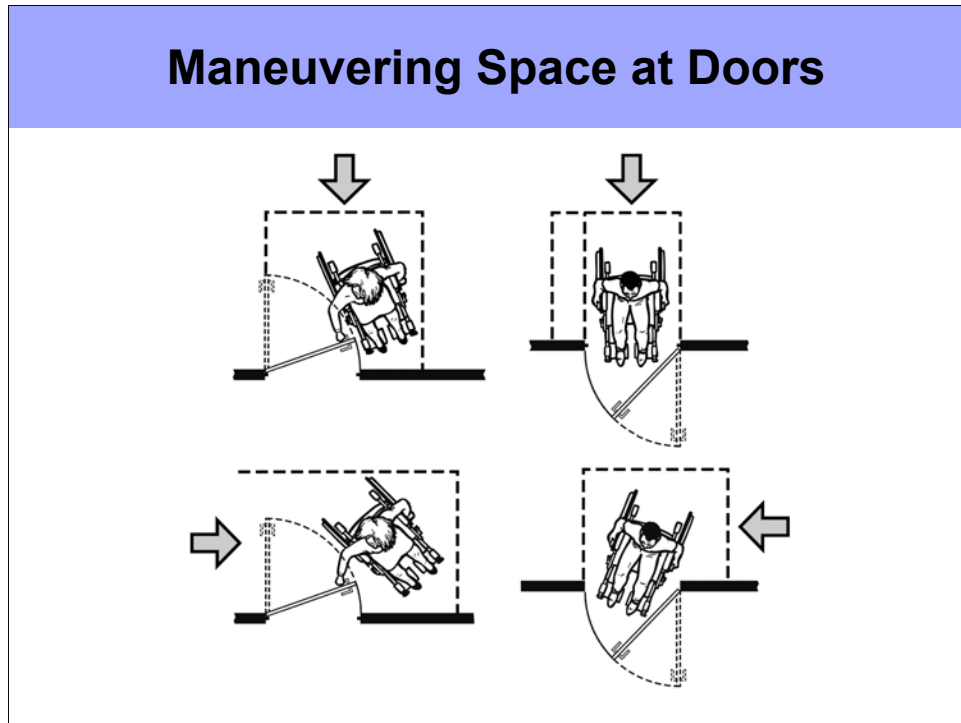

Maneuvering Space at Doors

ANSI provides minimum specifications for maneuvering space at doors. The size of the clear floor space varies based on how a person in a wheelchair or scooter approaches the door and ranges in size from 36" by 48" to 60" by 72".

Notes:

Clear Floor Space



Clear Floor Space

A key maneuvering space requirement is a minimum 18" clear floor space on the pull side of the door. This space allows someone to position themselves to the side so they are outside the swing of the door as it is opened.

Notes:



Primary Entrance Door

The exterior of the primary entrance doors to dwelling units face public areas and are required to have usable hardware.

All public and common use doors must be equipped with hardware that can be used without tight grasping or twisting; lever handle designs are a successful solution.

Once inside a dwelling, doors are not required to have usable hardware.

Notes:

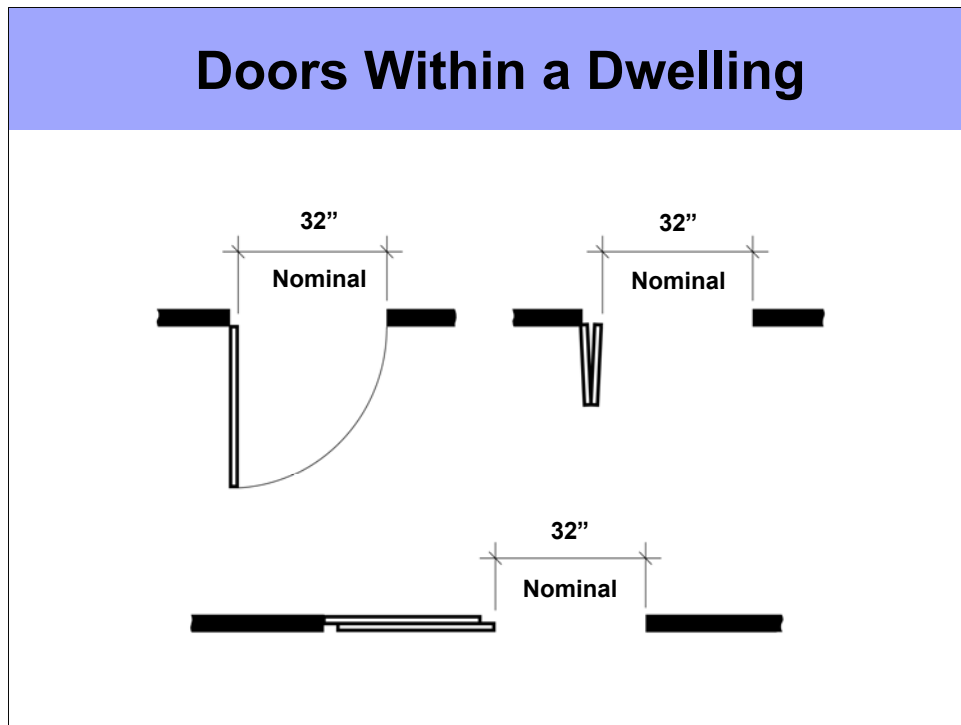

Doors Within a Dwelling

All doors intended for passage within dwelling units must provide a nominal 32" clear opening.

This applies to doors to walk-in storage rooms, closets, and pantries. When more than one door passes into a space, all are required to meet passage width specifications.

Notes:

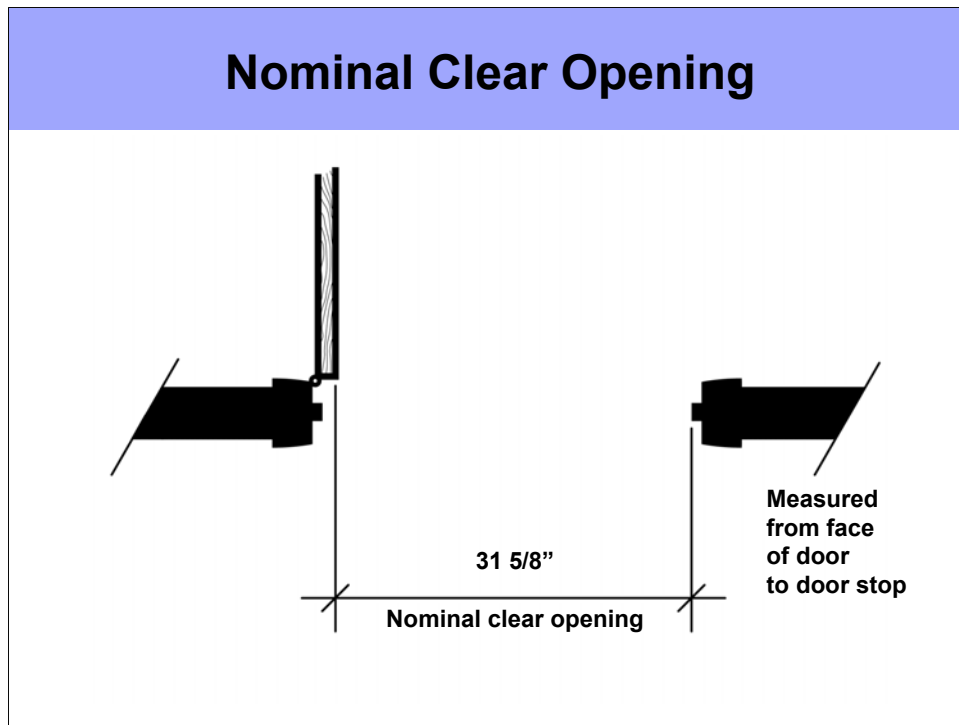

Nominal Clear Opening

The Guidelines adopt the term "nominal" to distinguish door width in covered units from door width in public areas that must provide an actual 32" clear opening.

Inside units, the 32" nominal door width allows builders and designers to use standard 34" wide doors which sometimes provide slightly less than a 32" clear opening. A nominal 32" clear opening is between 31 5/8" and 32" wide.

Notes:



Sliding Glass Doors

Many 6' wide sliding glass door units, when the 3' wide operable panel is fully open do not provide a nominal 32" clear opening. Manufacturers specifications must be carefully reviewed before choice of doors is made.

Notes:

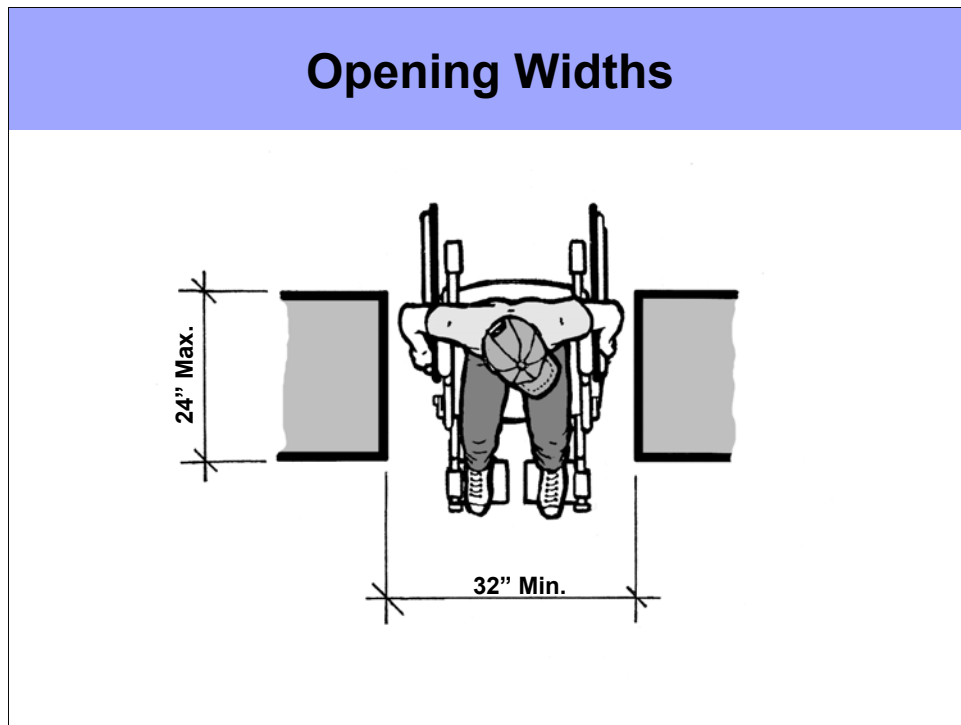

Opening Widths

Opening passages without doors must meet the minimum nominal clear opening width for doors up to a passage depth of 24".

Openings with passage depths 24" or greater must comply with accessible route width requirements and be no less than 36" wide.

Notes:

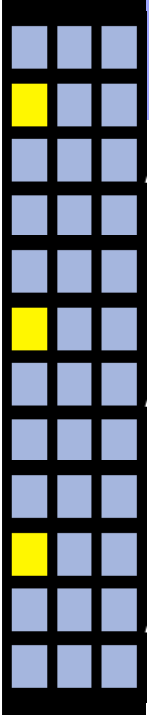

Technical Overview - Agenda

- Overview of the Fair Housing Act
- Technical Requirements of the Fair Housing Act
 - Requirement 1
 - Requirement 2
 - Requirement 3
 - **Requirement 4**
 - Requirement 5
 - Requirement 6
 - Requirement 7
- Strategies for Compliance
- Resources

Notes:

Requirement 4

Accessible Route Into and Through the Covered Unit

4

Requirement 4

Requirement 4 calls for an Accessible Route Into and Through the Covered Unit.

Requirement 4 applies to accessible routes that begin at the primary entrance door to a unit and continue through the dwelling unit onto decks, balconies, and patios.

Accessible routes that are part of public and common use areas are covered under Requirement 2, and must comply with applicable sections of ANSI A117.1.

Accessible routes within dwelling units must comply with minimum specifications in Requirement 4.

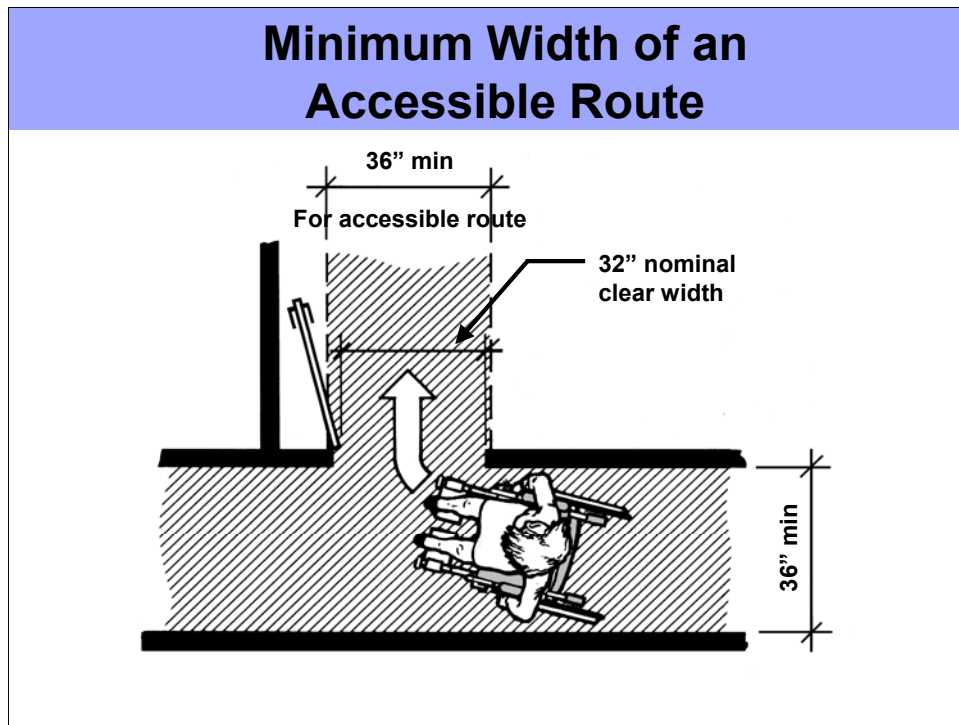

Minimum Width of an Accessible Route

Within a covered dwelling unit, the accessible route must be 36" wide or wider. However, where accessible routes pass through doors, the width may be reduced to a nominal 32" (31-5/8").

Notes:

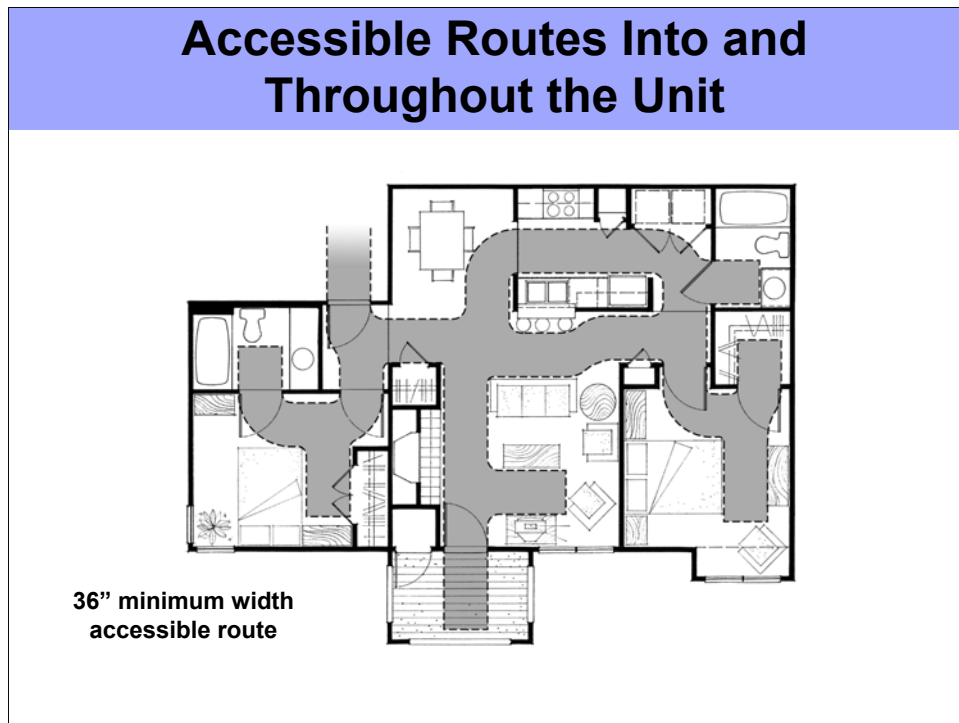

Accessible Routes Into and Throughout the Unit

An accessible route must be provided into all spaces intended for passage: kitchens, bathrooms, walk-in closets and pantries, hallways and the primary entrance stoop.

A patio or deck, depending on how it is constructed, may also have to be on an accessible route. This will be discussed shortly.

Notes:

Accessible Routes in Compact Units



Accessible Routes in Compact Units

It is possible to provide an accessible route into and through all types of dwelling unit plans, even in compact units, such as this illustration.

Notes:

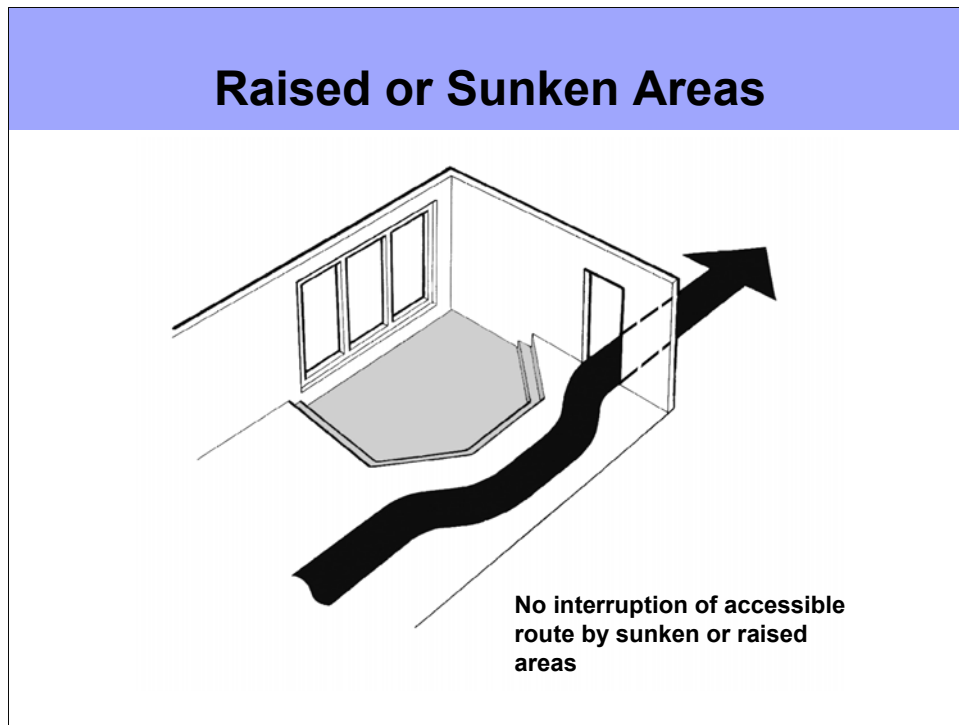

Raised or Sunken Areas

The Guidelines specify a dwelling may have one area within a room that is either sunken or raised.

Only one sunken or raised area is allowed per unit and it may not interrupt the accessible route through the unit. A bathroom or kitchen may not be located within a raised or sunken area.

A loft is permitted and must meet the same specifications as raised or sunken areas. A unit with a loft may not have a sunken or raised area.

Notes:

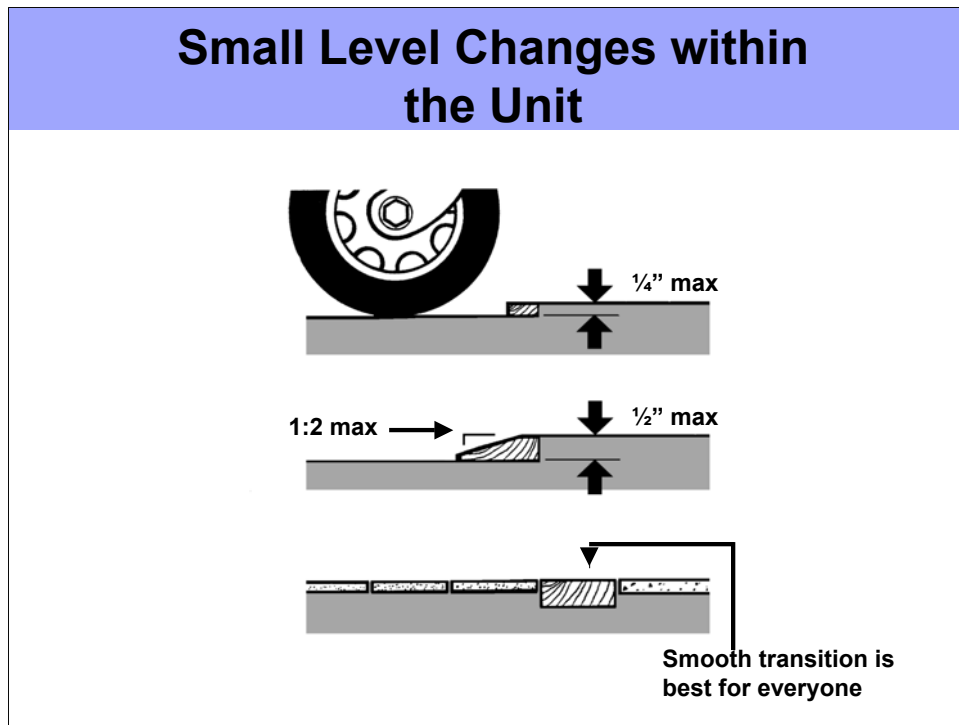

Small Level Changes within the Unit

Within dwelling units, small level changes that meet the following requirements are allowed:

- 1/4" maximum vertical level change
- Level change between 1/4" and 1/2" must be beveled 1:2 or less
- Level changes greater than 1/2" must be sloped 1:12 or less

A smooth transition between different areas is most usable.

Notes:

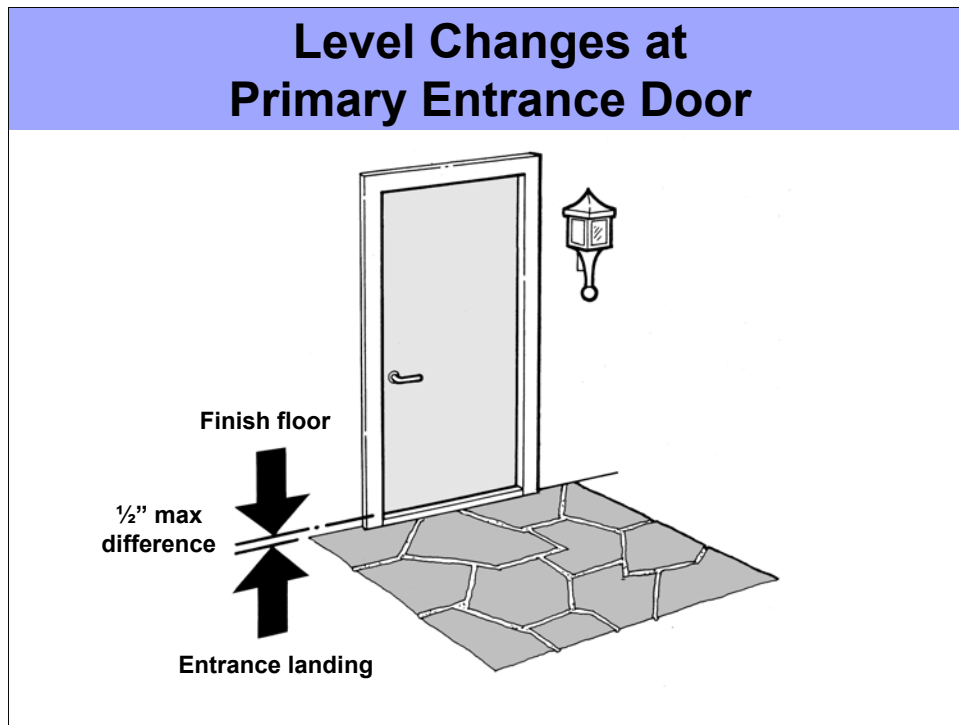

Level Changes at Primary Entrance Door

At primary dwelling entrance doors, if the exterior landing is of impervious construction, the landing may be no more than 1/2" below the floor of the unit.

If pervious, the interior and exterior floors must be flush.

Notes:

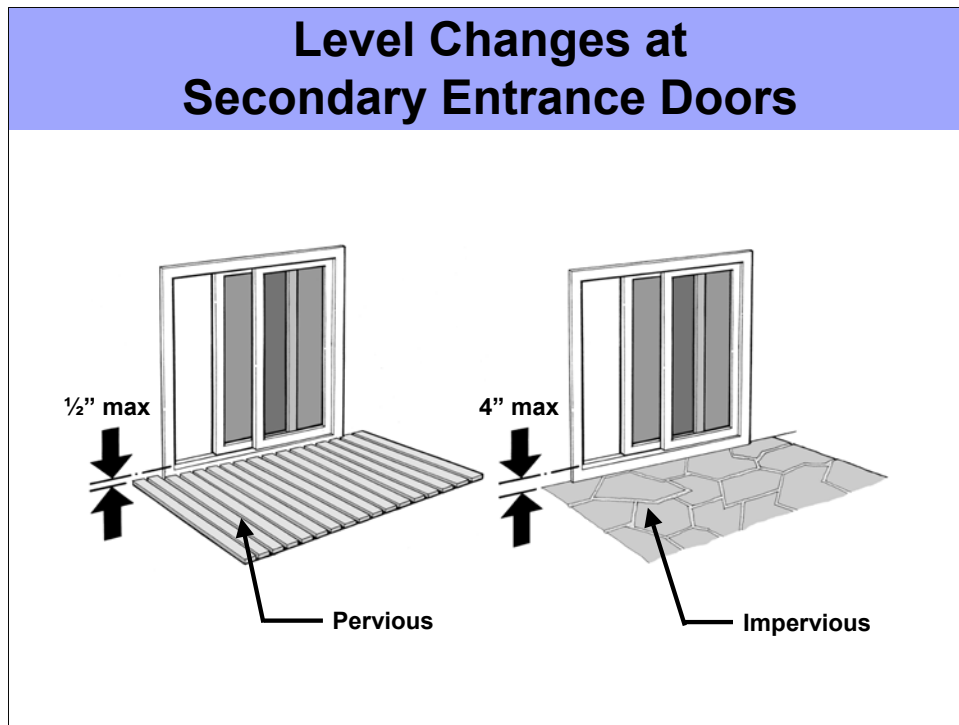

Level Changes at Secondary Entrance Doors

At a secondary entrance, if the landing is of pervious material, such as a wood deck, it may be only 1/2" or less below the level of the finished floor.

If the landing is of impervious material, such as concrete, brick or stone, the landing may be dropped a maximum of 4" below the level of the finished floor of the unit.

Notes:

Level Changes at Secondary Entrance Doors



Level Changes at Secondary Entrance Doors

Even though the Guidelines allow up to a 4" drop at secondary doors to patios built of impervious surfaces, designers and providers should be aware that such level changes may leave the deck, balcony, or patio inaccessible to persons with disabilities.

Notes:

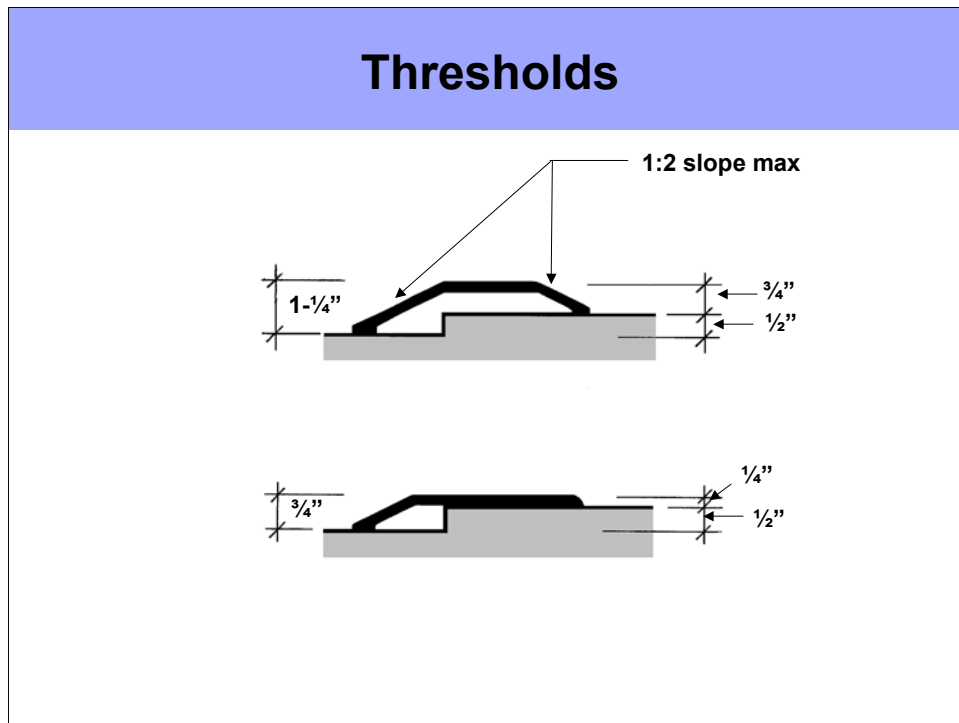

Thresholds

Requirement 4 also provides specifications for accessible thresholds. Thresholds at primary and secondary entrance doors must:

1. Be no higher than $\frac{3}{4}$ " above finish floor
2. The vertical level change must be beveled 1:2 or less
3. Abrupt vertical level changes on the threshold must not exceed $\frac{1}{4}$ "

The top illustration shows the maximum sloped condition for a threshold permitted at a primary entrance door. With an impervious landing on the exterior side, note the maximum allowed drop of $\frac{1}{2}$ " at the entrance landing, the height of the threshold is $1 \frac{1}{4}$ " from the exterior landing. On the interior side the maximum allowed height of the threshold is $\frac{3}{4}$ " above finish floor.

The lower illustration shows the same $\frac{1}{2}$ " maximum level change at the exterior landing, but a lower profile threshold is shown. The lower profile is easier for people who use wheelchairs and other mobility aids to cross.

On both the interior and exterior sides, thresholds must be beveled 1:2 or less.

Covered Entrances



Covered Entrances

Water infiltration at building entrances has always been a concern of designers and builders. By far, the most effective way to minimize potential problems is to provide a covered entrance, which, although not required, is an amenity that benefits all users.

Notes:

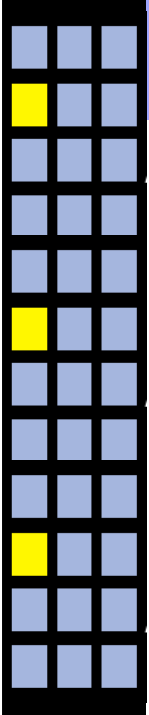

Technical Overview - Agenda

- Overview of the Fair Housing Act
- Technical Requirements of the Fair Housing Act
 - Requirement 1
 - Requirement 2
 - Requirement 3
 - Requirement 4
 - **Requirement 5**
 - Requirement 6
 - Requirement 7
- Strategies for Compliance
- Resources

Notes:

Requirement 5

**Light Switches, Electrical Outlets,
Thermostats, and Other Environmental
Controls in Accessible Locations**

5

Requirement 5

Requirement 5 specifies light switches, electrical outlets, thermostats, and other environmental controls be located in accessible locations.

The type of switches, outlets and controls that must be placed in accessible locations are those used by residents on a frequent or regular basis. Examples include thermostats and other heating, air-conditioning and ventilation controls including ceiling fans. Light switches and room outlets are also covered under Requirement 5.

Notes:

Controls Not Covered

- Controls on movable appliances
- Hoods over ranges
- Special use wall outlets
- Telephone jacks
- Circuit breaker panels

Controls Not Covered

The following items are not covered under Requirement 5:

- Controls on movable appliances
- Hoods over ranges
- Special use wall outlets, such as refrigerator and electric range outlets
- Telephone jacks
- Circuit breaker panels

If there is a range (with an oven) or wall-mounted oven in a kitchen, then microwave ovens located in range hoods or mounted to the underside of upper cabinets are not covered.

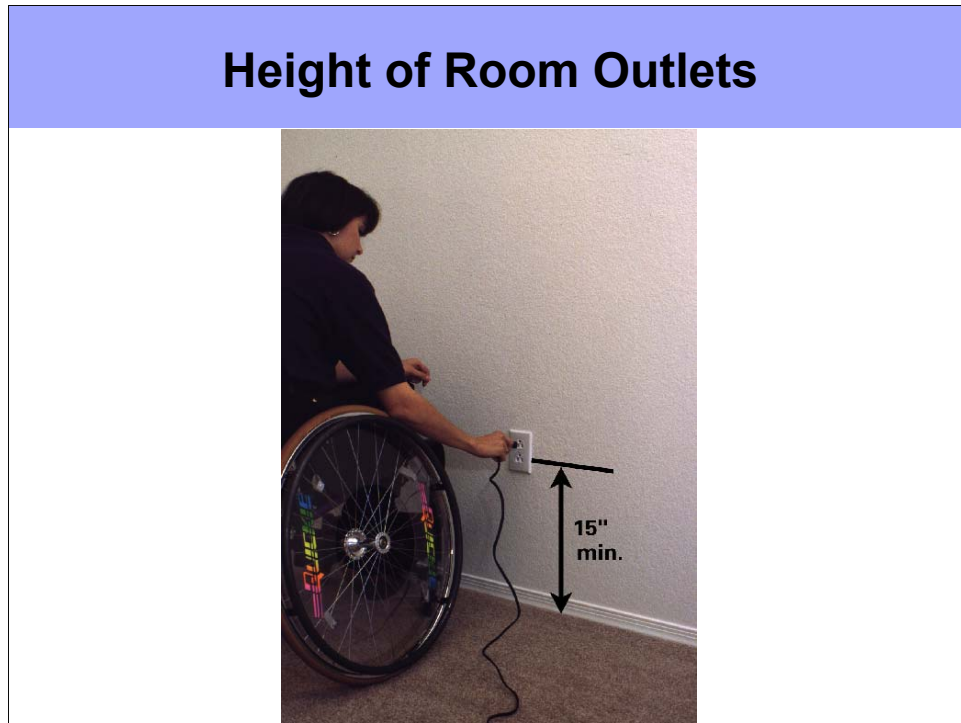

Height of Room Outlets

The Guidelines specify room outlets must be located so that all operable parts of the receptacles are 15" or greater above finish floor. In this duplex outlet, the lower receptacle must be 15" or greater above finish floor.

Notes:

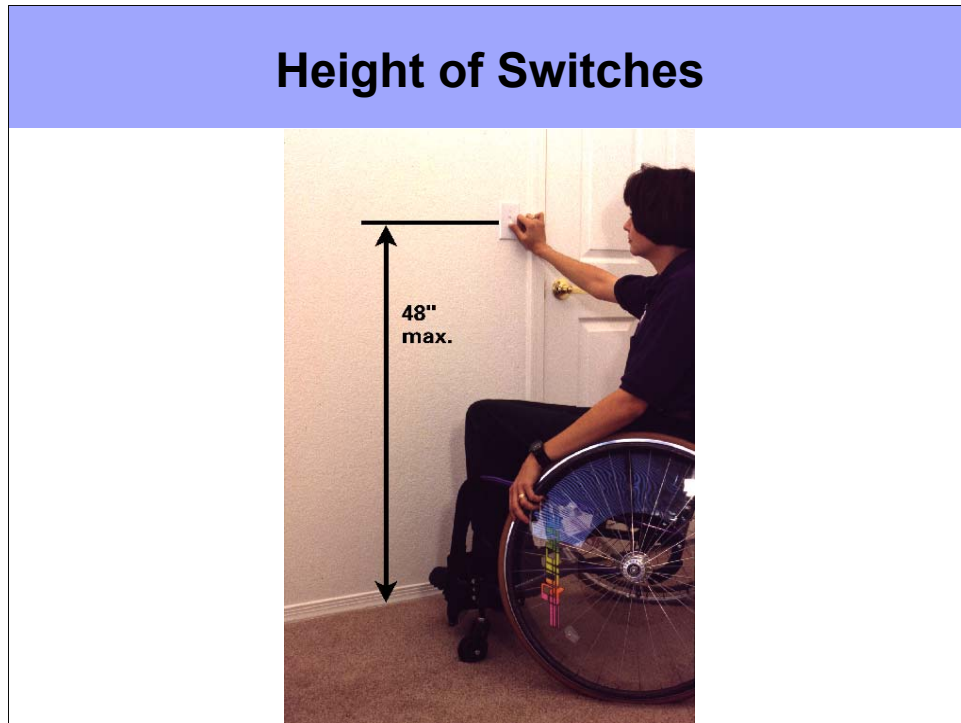

Height of Switches

The Guidelines state that switches, thermostats and other environmental controls must be mounted no higher than 48" above finish floor. This height applies regardless if the position of a wheelchair can make a parallel or forward approach.

Notes:

Controls Located Over Obstruction Without Knee Space

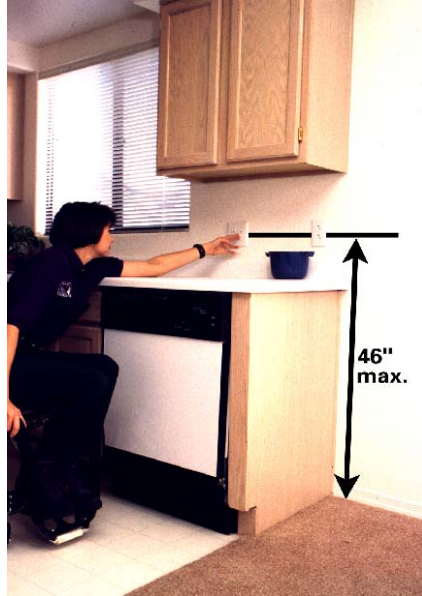

Controls Located Over Obstruction Without Knee Space

If controls, switches, and outlets are located on a wall over an obstruction up to 24" in depth not having knee space, such as this kitchen counter, the maximum mounting height is reduced to 46".

Notes:

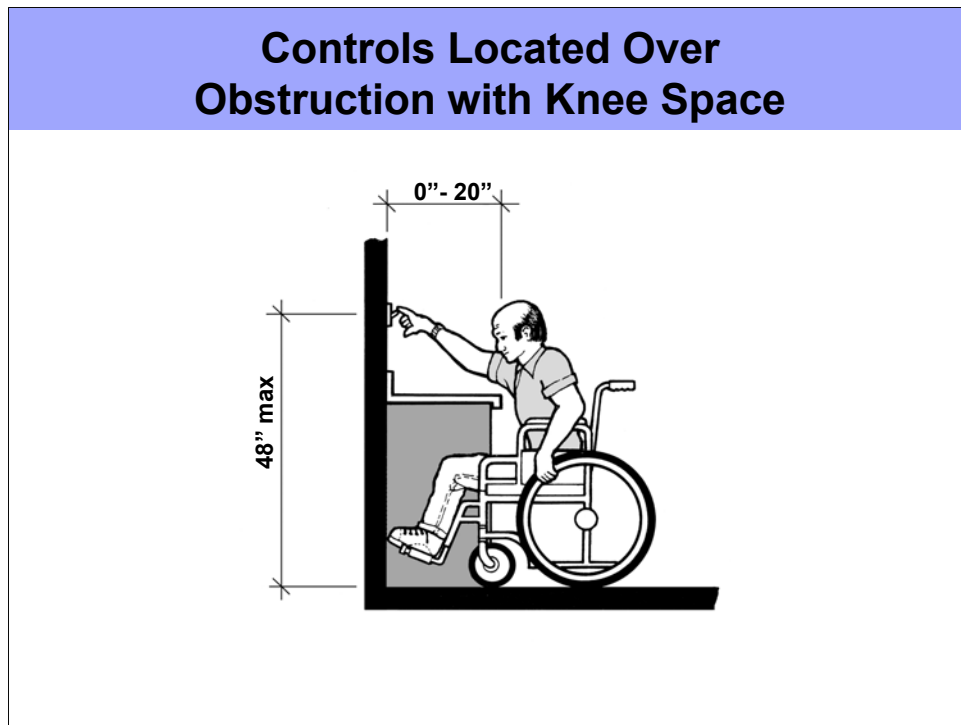

Controls Located Over Obstruction with Knee Space

Controls, switches, and outlets located over an obstruction extending 0" to 20" from the wall with a full depth knee space, must be mounted no higher than 48" above the floor.

Notes:

Controls Located Over Obstruction With Knee Space

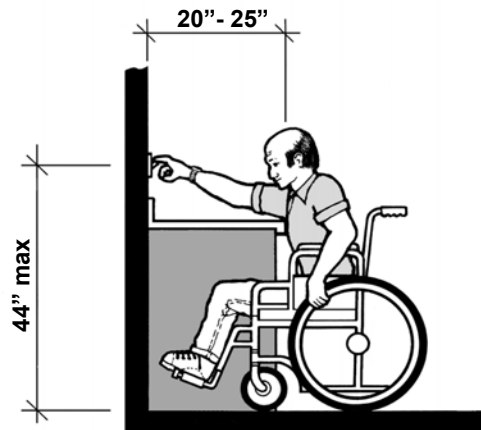

Controls Located Over Obstruction With Knee Space

For a deep obstruction of 20" to 25" with knee space, like a desk, the controls or switches must be mounted no higher than 44" above the floor.

Notes:

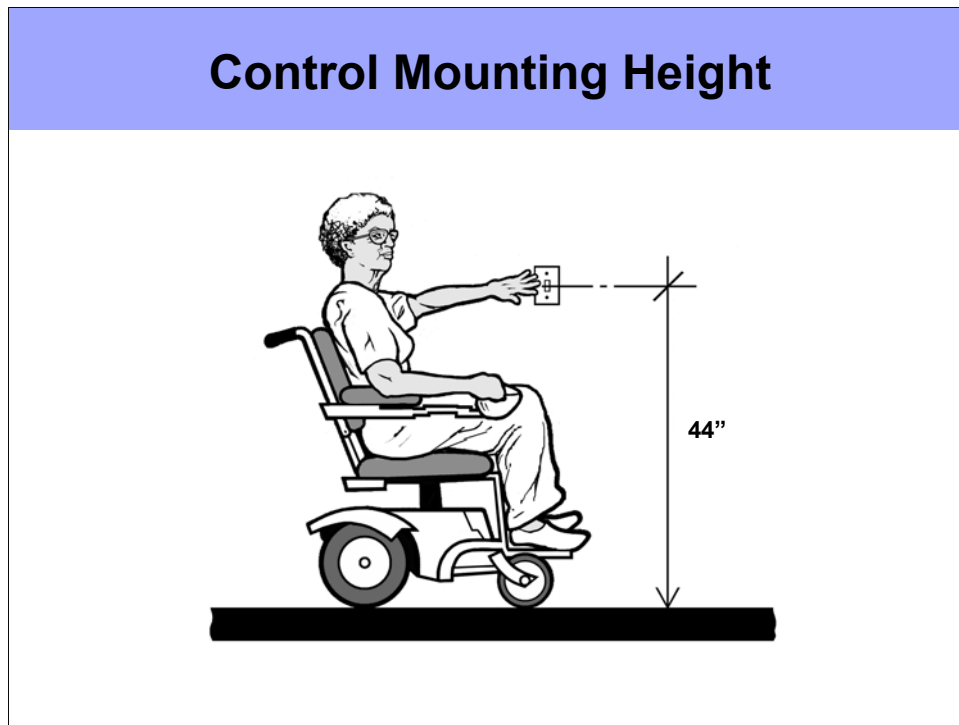

Control Mounting Height

The Guidelines provide a number of allowable heights for controls depending on whether they are located over an obstruction with or without knee space. Although not required, compliance is greatly simplified by adopting a single height of max. 44" for the higher limit for locations of switches, thermostats, and outlets located over obstructions.

Notes:

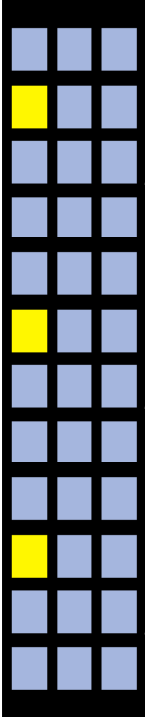

Technical Overview - Agenda

- Overview of the Fair Housing Act
- Technical Requirements of the Fair Housing Act
 - Requirement 1
 - Requirement 2
 - Requirement 3
 - Requirement 4
 - Requirement 5
 - **Requirement 6**
 - Requirement 7
- Strategies for Compliance
- Resources

Notes:

Requirement 6

Reinforced Walls for Grab Bars

6

Requirement 6

Requirement 6 specifies that reinforcing be installed in bathroom walls to allow for future installation of grab bars around toilets, bathtubs and shower stalls. In some situations, reinforcing for shower seats is also required.

However, the only grab bars that must be installed at the time of construction are in public and common use toilet rooms and bathing facilities.

The Guidelines illustrate the minimum areas to be reinforced at toilets, tubs, and showers.

Although these minimum areas for reinforcement specified in the Guidelines meet compliance, many standard grab bar lengths may not be able to be safely anchored within these limited reinforced areas.

Minimum Reinforcing Behind Toilets

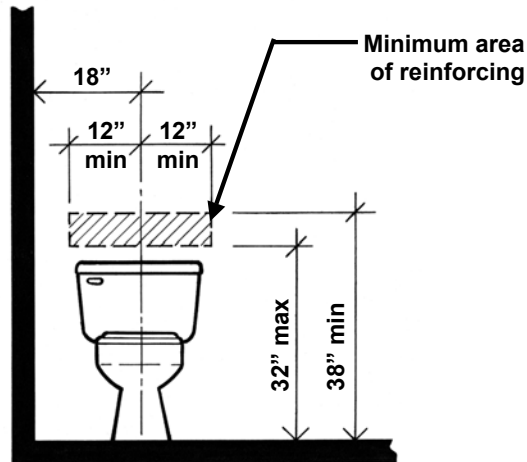

Minimum Reinforcing Behind Toilets

The Guidelines specify that a minimum sized 6" wide by 24" long reinforcing be provided behind toilets.

Notes:

Minimum Reinforcing at Side of Toilets

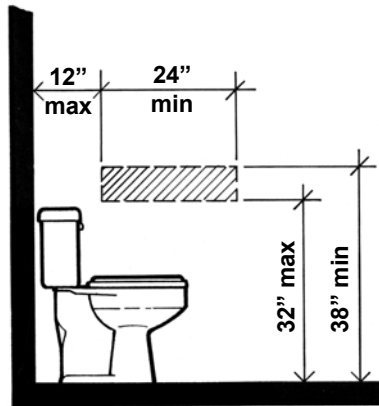

Minimum Reinforcing at Side of Toilets

When the toilet is located against an adjacent side wall, reinforcing must be installed along the side of the toilet.

Reinforcing around toilets in powder rooms is required when the powder room is the only toilet facility on the entry level of a multi-story dwelling unit in an elevator building.

Notes:

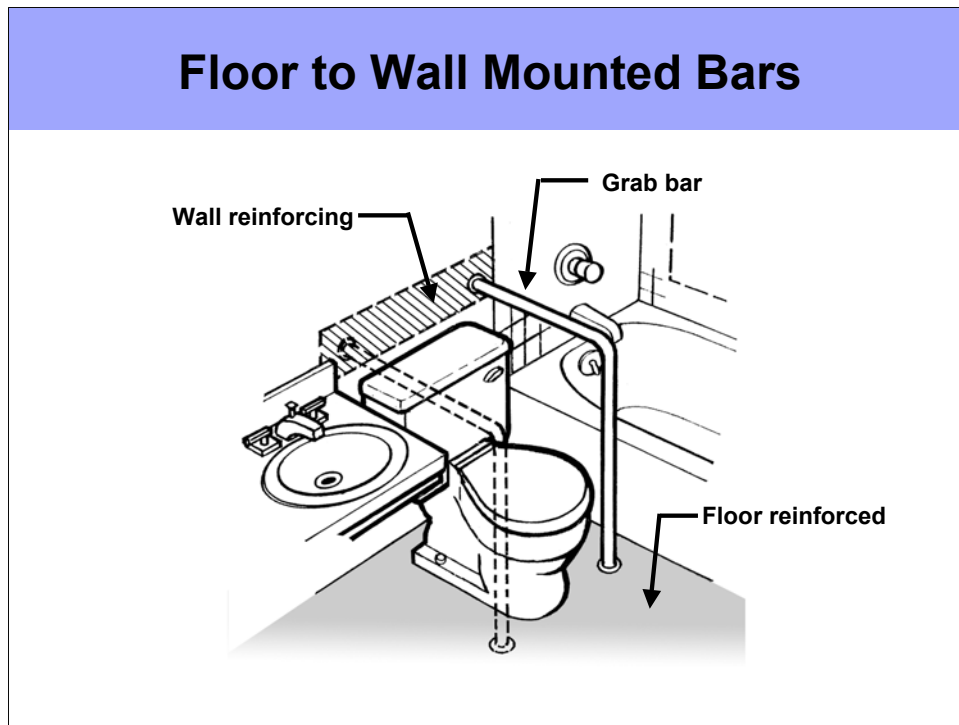

Floor to Wall Mounted Bars

In conventional bathrooms, where the toilet is between a lavatory and bathtub, reinforcing must be provided for either wall-to-floor mounted or fold-down grab bars. The illustration above illustrates areas that must be reinforced for a wall-to-floor mounted grab bar.

Notes:

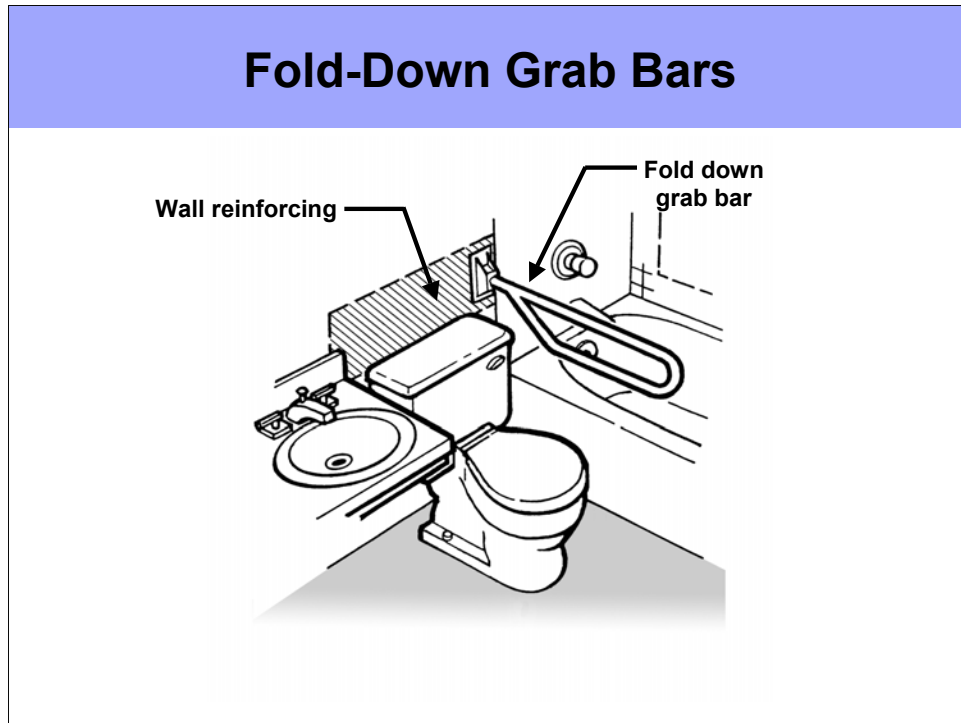

Fold-Down Grab Bars

Wall reinforcing provided for installation of a fold-down bar is also allowed.

Notes:

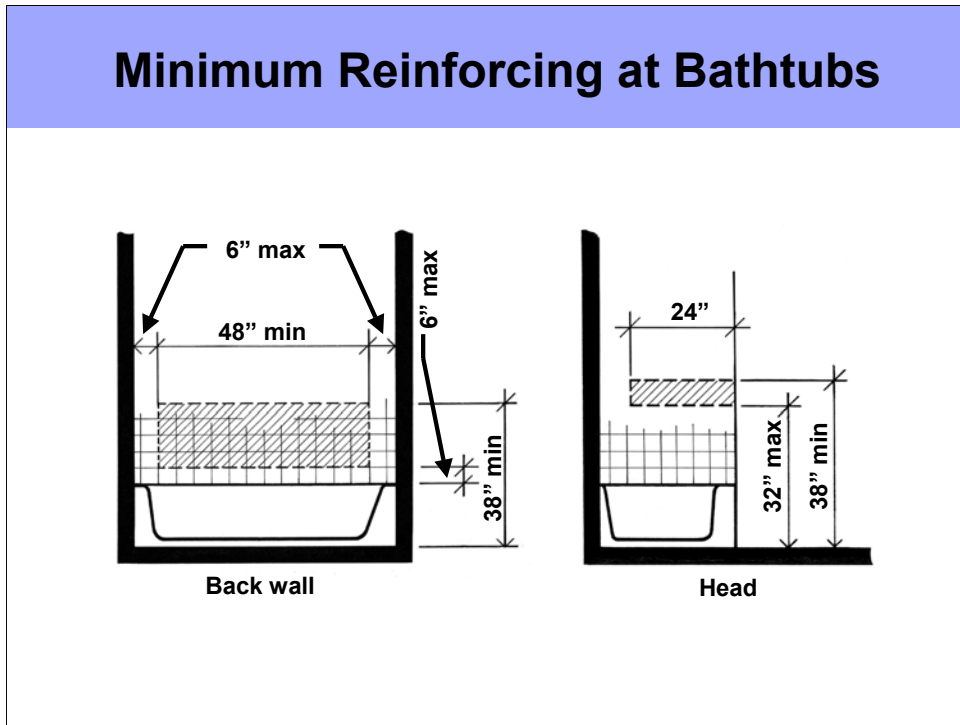

Minimum Reinforcing at Bathtubs

The Guidelines also specify minimum lengths and locations for grab bar reinforcing around conventional bathtubs. Here too, the Guideline specifications are minimums. Additional reinforcing is recommended to accommodate a wider range of grab bar configurations.

Notes:

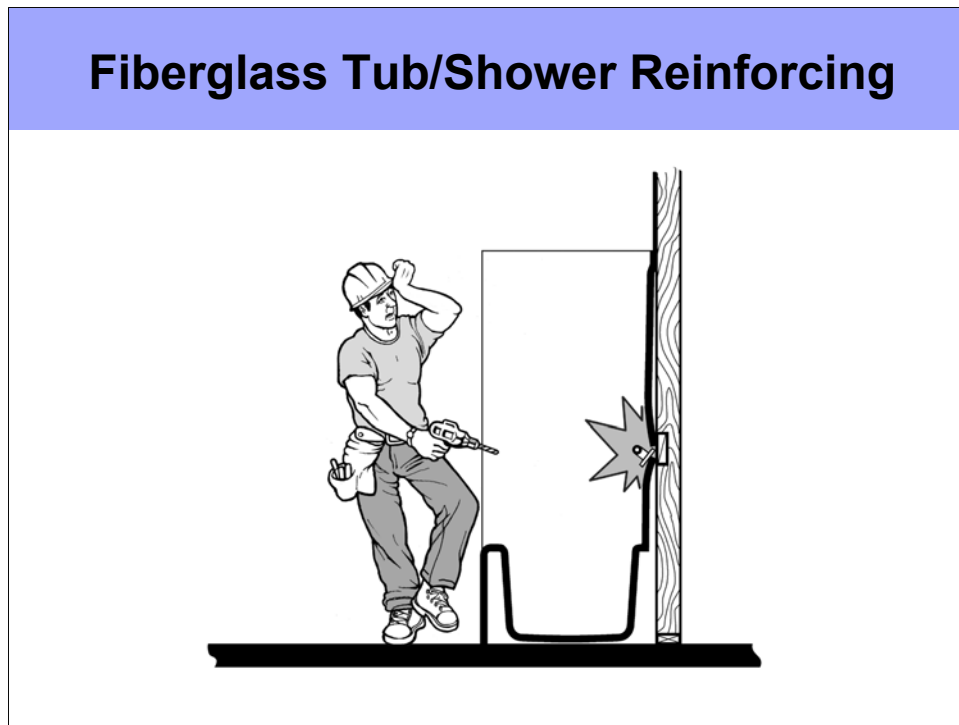

Fiberglass Tub/Shower Reinforcing

Fiberglass tub/shower units present special considerations:

1. Most of these bathing fixtures are manufactured with sidewalls that are normally held off the face of the backing wall by as much as 2" to 3" or more.
2. With blocking placed in the plane of the back wall, the sidewalls of the fiberglass bathing module could buckle or crack if someone tried to anchor a grab bar.
3. Fiberglass tub/shower fixtures frequently have molded elements along the back and side walls that thwart the installation of grab bars. The sidewalls and back wall must be flat in the areas where reinforcing is required.

For these reasons, fiberglass bathing modules should be specified and provided with integral reinforcing cast into the side walls in the factory at compliant locations.

This issue is covered in the questions and answers on the FIRST website.

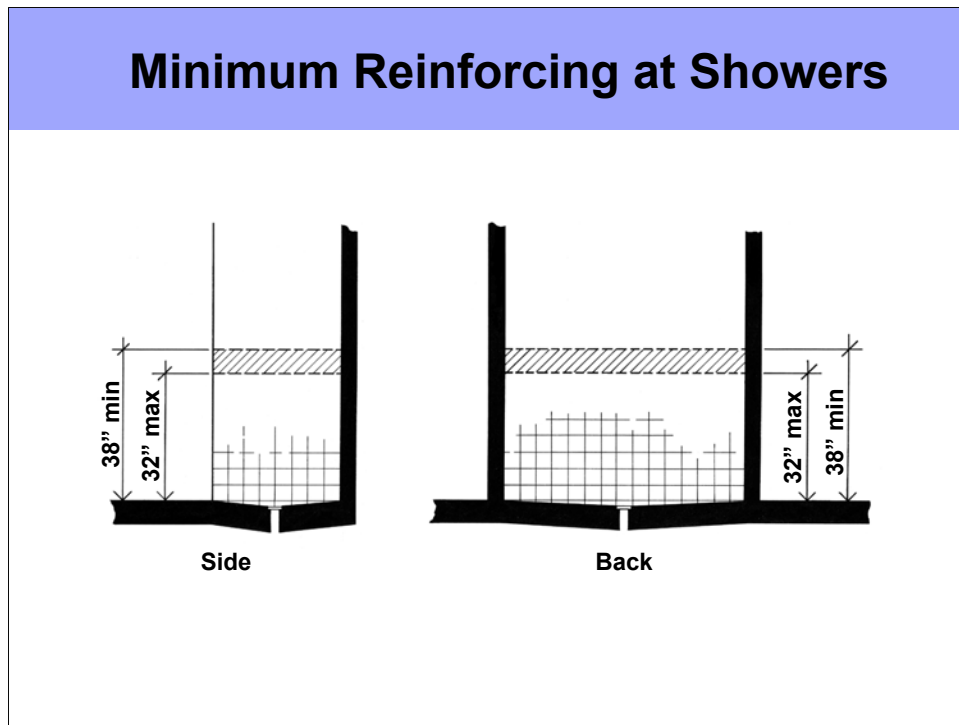

Minimum Reinforcing at Showers

Reinforcing in showers must be installed minimally between 32" and 38" above the floor and extend the full width of both sides and the back wall.

Notes:

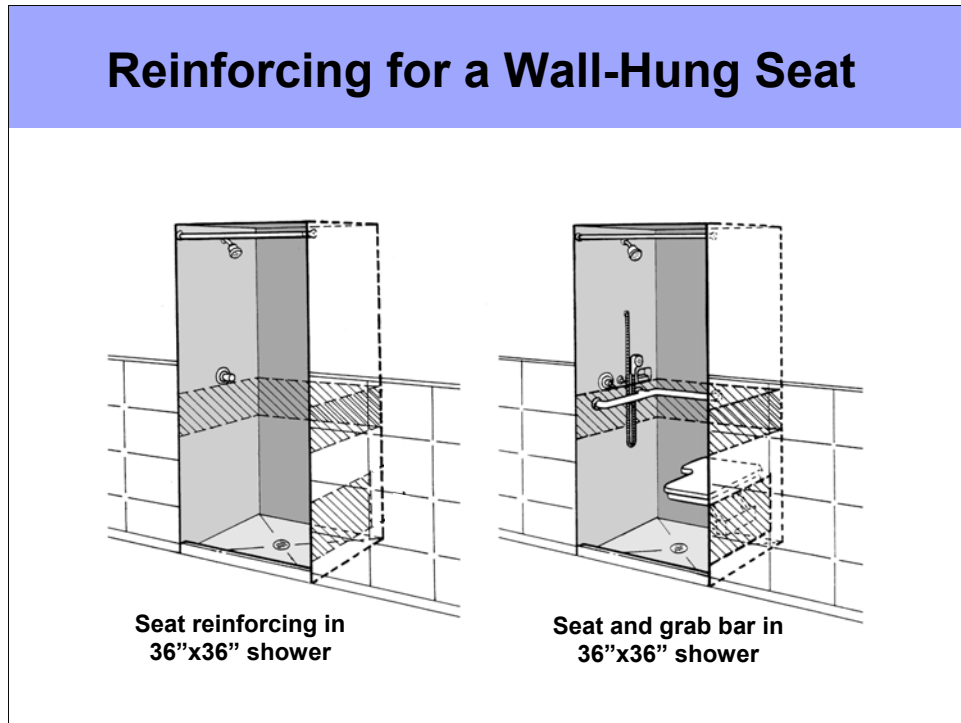

Reinforcing for a Wall-Hung Seat

When a shower is the only bathing fixture in a Specification B bathroom (discussed under Requirement 7), the shower stall must also have reinforcing for a wall-mounted seat.

Notes:

Materials for Reinforcing



Materials for Reinforcing

The Guidelines do not specify materials or methods for reinforcing. Builders commonly use cut-off from the framing process, plywood, or metal plates.

Notes:

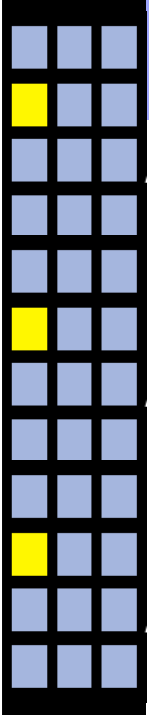

Technical Overview - Agenda

- Overview of the Fair Housing Act
- Technical Requirements of the Fair Housing Act
 - Requirement 1
 - Requirement 2
 - Requirement 3
 - Requirement 4
 - Requirement 5
 - Requirement 6
 - **Requirement 7**
- Strategies for Compliance
- Resources

Notes:

Requirement 7

Usable Kitchens and Bathrooms

7

Requirement 7

Kitchens and Bathrooms must be designed and constructed so a person in a wheelchair can maneuver about the space and use fixtures and appliances.

Notes:

Usable Kitchens

General Requirements:

- Clear Floor Space at Appliances
- Clearance between Countertops, Appliances, and Walls
- Clearance in U-Shaped Kitchens

Usable Kitchens

The Guidelines give a set of kitchen specifications which, when applied, provide a minimum level of accessibility.

There are three general requirements in the Guidelines to create usable kitchens:

1. Clear floor space at appliances
2. Clearance between countertops, appliances and walls
3. Turning and clearance requirements in U-shaped kitchens

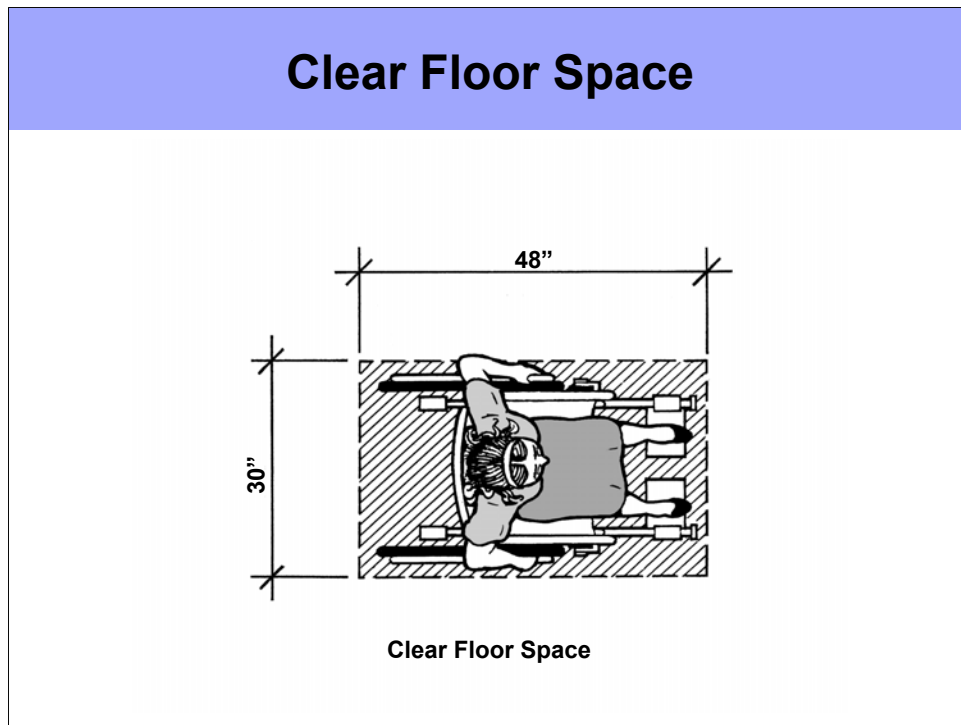

Clear Floor Space

A basic building block used in the Guidelines is a clear floor space of 30"x48". This is also the standard used in ANSI, ADAAG, and other accessibility standards.

This 30"x48" area is the approximate space occupied by an average-sized adult in a conventional wheelchair.

Notes:

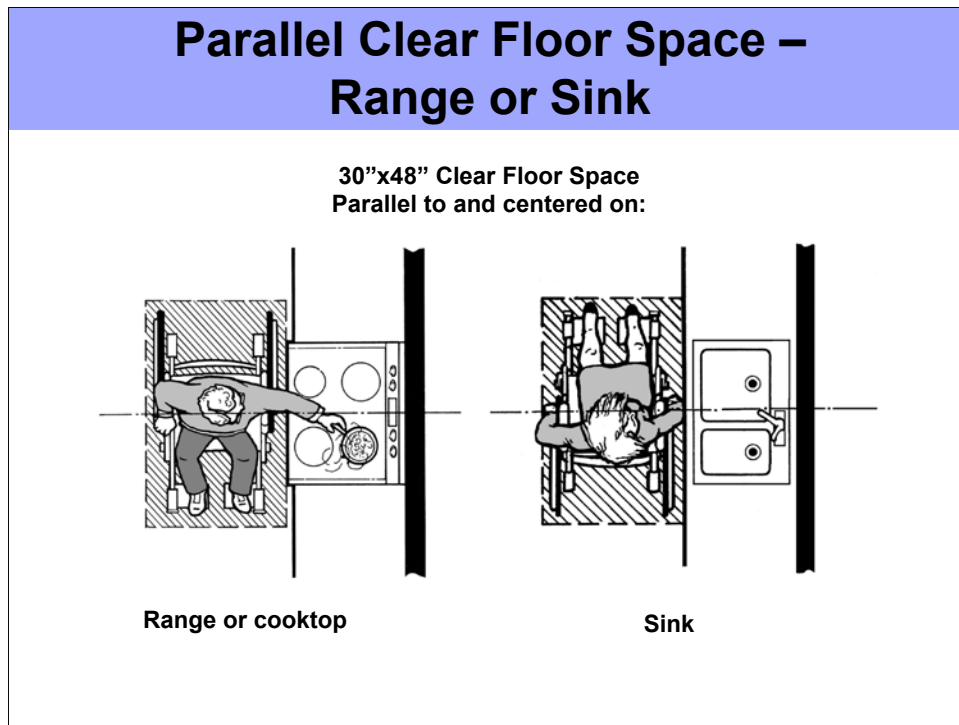

**Parallel Clear Floor Space –
Range or Sink**

At ranges, cooktops, and kitchen sinks, there must be a 30"x48" clear floor space parallel-to and centered-on the fixture.

Notes:

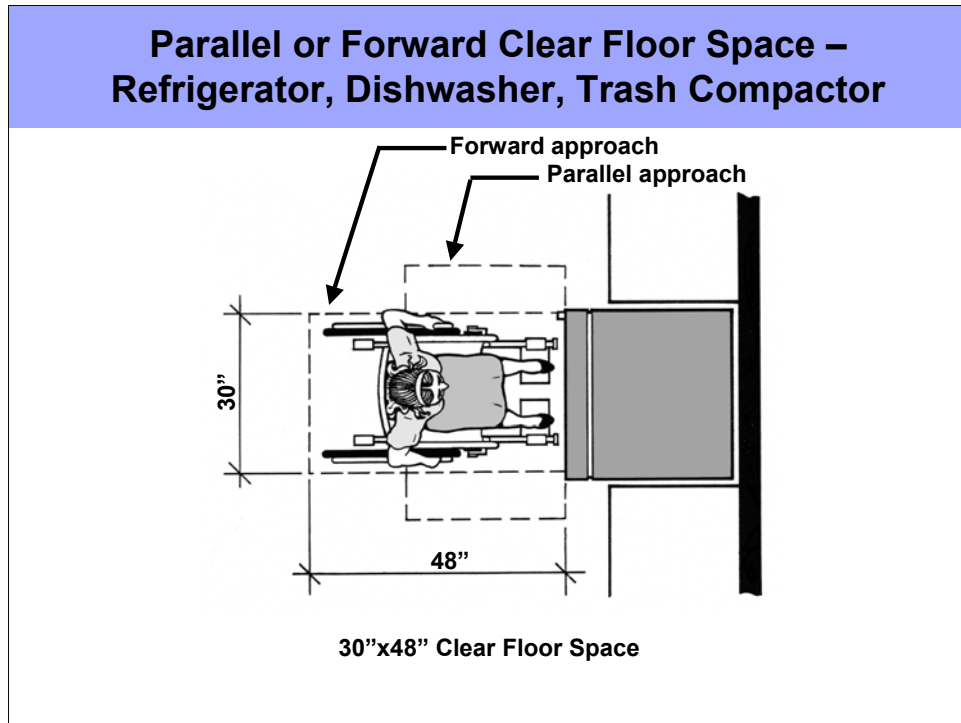

**Parallel or Forward Clear Floor Space –
Refrigerator, Dishwasher, Trash Compactor**

At ovens, dishwashers, refrigerators, and trash compactors, the required 30"x48" clear floor area must be positioned for either a parallel or forward approach, and be centered on the appliance.

Notes:

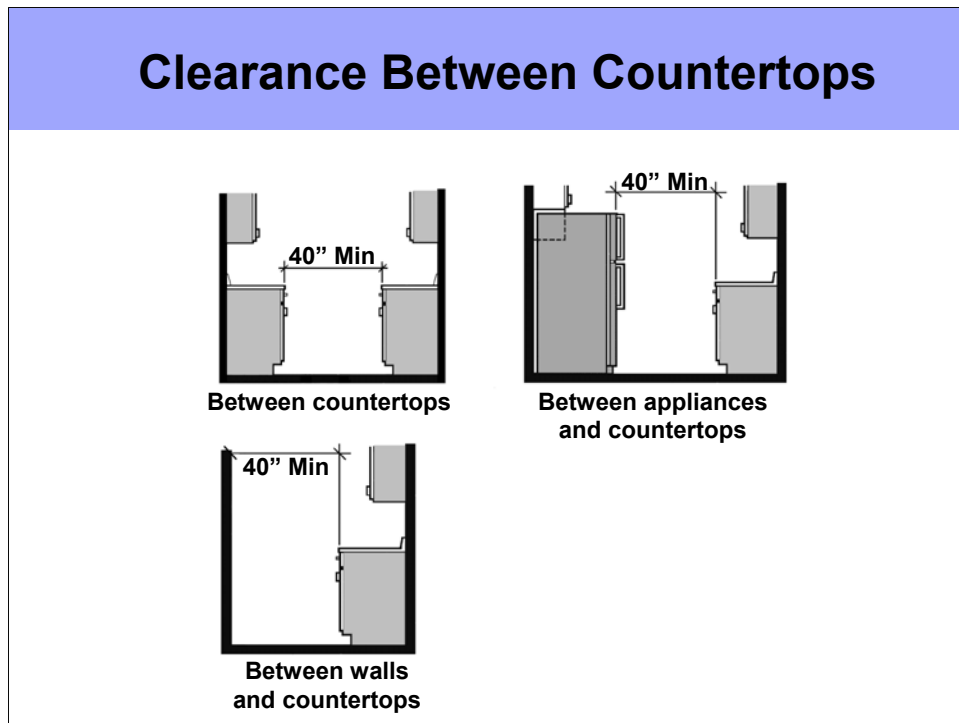

Clearance Between Countertops

A minimum clearance of 40" must be provided between all opposing cabinets, countertops, appliances, or walls. Handles of appliances may overlap into the clearance area.

If there is a cabinet without a countertop, such as a full length pantry cabinet, the clearance must be provided between the face of the cabinet and the opposing countertop, appliance, or wall.

This issue is covered in the questions and answers on the FIRST website.

Notes:

Galley Kitchen – 40” Clearance

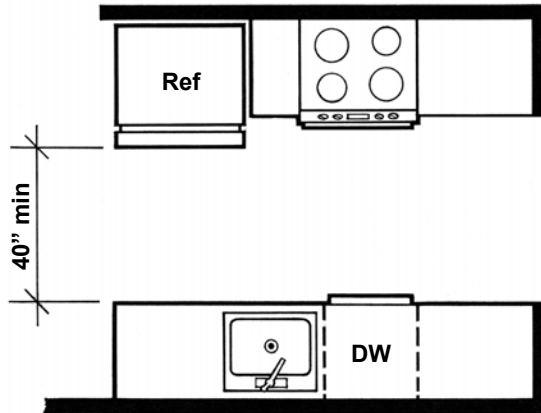

Galley Kitchen – 40” Clearance

Care must be exercised when designing kitchens because appliances, such as refrigerators and ranges, generally extend beyond the standard 25” countertops. In a galley style kitchen, the 40” clearance must be maintained between the countertop and any appliance, fixture, or cabinet on the opposite wall.

Notes:

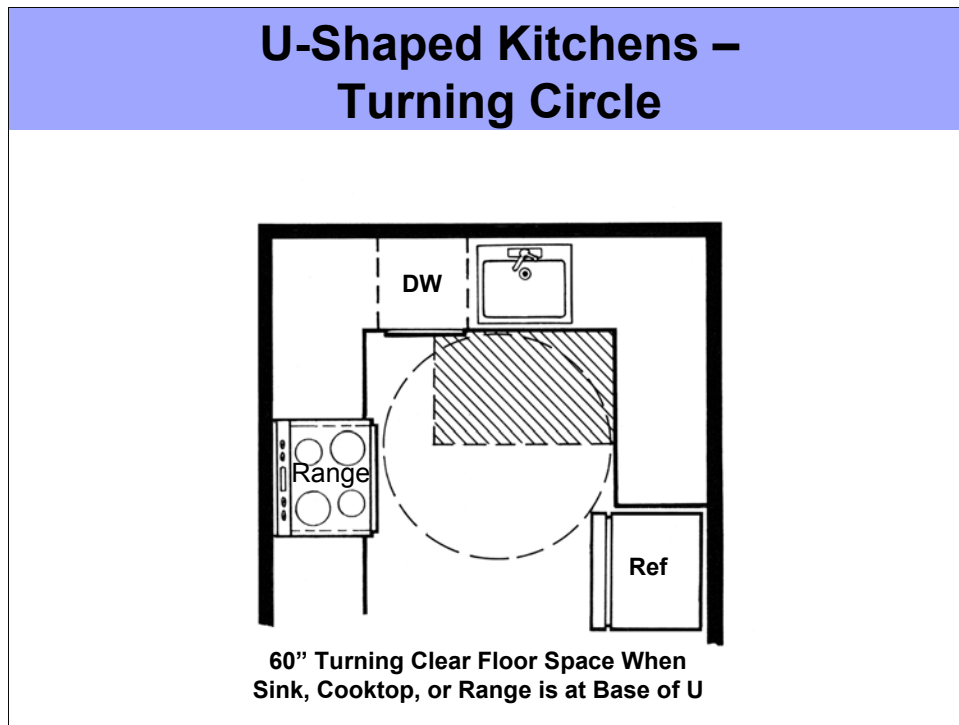

U-Shaped Kitchens – Turning Circle

In U-shaped kitchens where a sink, range, or cooktop is located at the base of the "U", there must be a minimum 60" diameter maneuvering space to allow a person using a wheelchair or scooter to maneuver and make a parallel approach to the sink, range or cooktop.

Depending on the cabinet layout, choice of appliances, and plumbing fixtures, a larger area may result when meeting all the clearance requirements.

Notes:

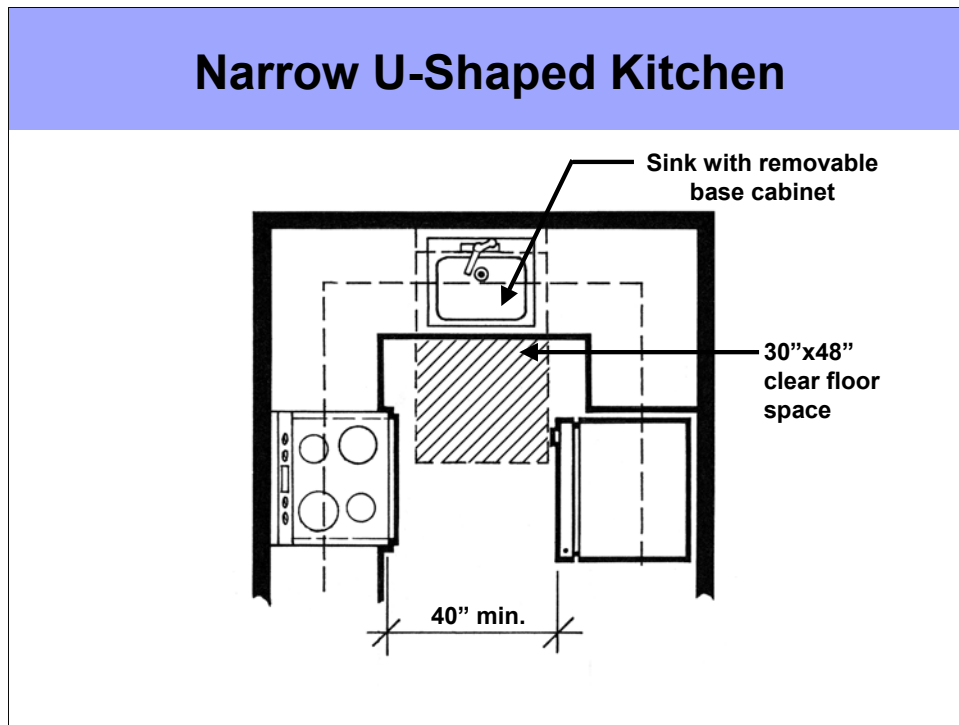

Narrow U-Shaped Kitchen

A narrow U-shaped kitchen is permitted, but only if there is knee space or an easily adaptable cabinet is provided under the cooktop or sink. If permanent knee space is not provided, removable base cabinets must be provided and the area under and around the sink must be finished.

The minimum distance of 40'' must be maintained between opposing cabinets, countertops, appliances, and walls, and there must be compliant clear floor space at all appliances.

Notes:

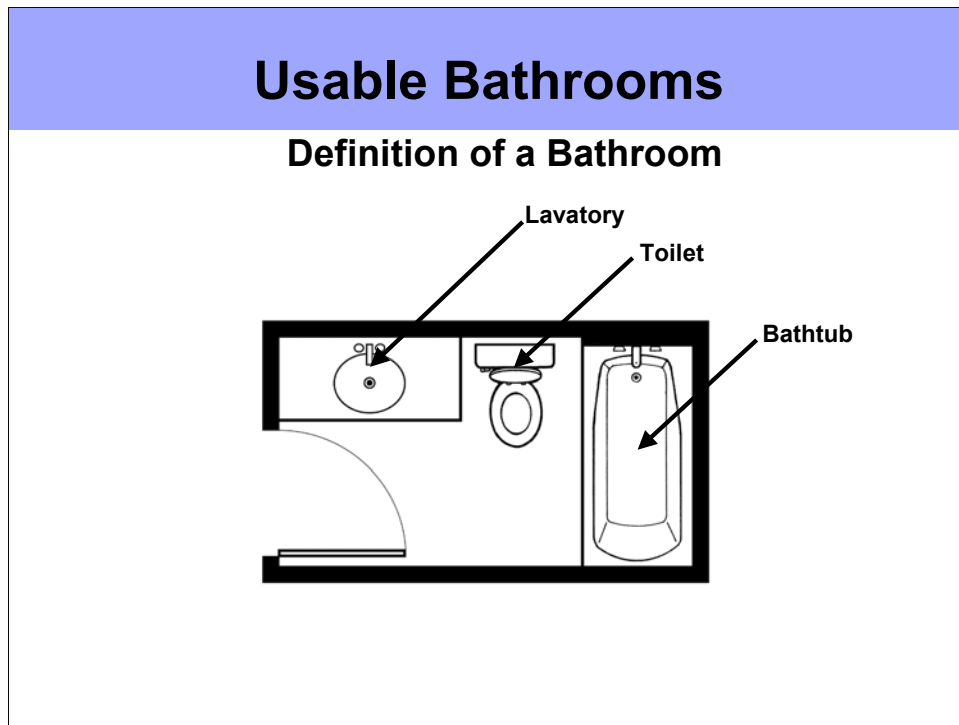

General Requirements For Bathrooms

The Guidelines provide specifications and design choices that, when properly applied, result in bathrooms that provide compliant levels of accessibility.

As in kitchens, the specifications provide for:

1. Maneuvering space within the bathroom
2. Minimum clearance requirements at fixtures

A bathroom is defined in the Guidelines as a bathroom containing a water closed (toilet), lavatory (sink), and a bathtub or shower. The fixtures may occur in one room or be compartmentalized in separate adjacent spaces. When a bathroom consists of multiple compartments, each compartment with a fixture required to be accessible, must meet the maneuvering and clear floor space requirements.

Usable Bathrooms

General Requirements:

- Clear floor space within the bathroom outside the swing of the door
- Clear floor space at bathroom fixtures

Usable Bathrooms

The Guidelines provide bathroom specifications which provide a minimum level of accessibility.

Specifications are provided for:

1. Clear floor space within the bathroom for a person using a wheelchair or other mobility aide to position themselves clear of the swing of the door.
2. Clear floor space at bathroom fixtures including lavatories, toilets and showers.

Notes:

General Requirements for Usable Bathrooms

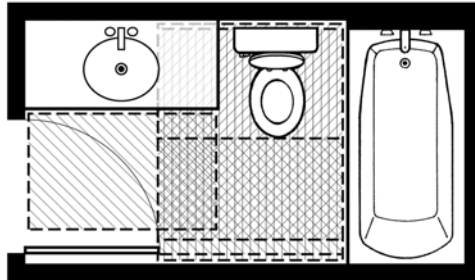

Clear floor space at each fixture
(clear floor spaces may overlap)

General Requirements for Usable Bathrooms

In addition to meeting clear floor space requirements, bathrooms must also meet the other applicable requirements:

- Have usable doors, Requirement 3—Usable Doors
- Be on an accessible route, Requirement 4—Accessible Route into and through the Unit
- Have outlets and switches in usable locations, Requirement 5—Outlets, Switches, and other Environmental Controls in Usable Locations
- Have reinforcing for grab bars at toilets, bathtubs, and showers, Requirement 6—Reinforced Walls for later installation of Grab Bars

Two Bathroom Specifications

Specification A

- Less accessible
- All fixtures must be usable

Specification B

- More accessible
- One of each fixture must be usable

Two Bathroom Specifications

To satisfy maneuvering and clear floor space requirements, the Guidelines provide two sets of specifications to design bathrooms, which will be referred to as Specification A and Specification B in this presentation.

Some of the key differences between Specification A and Specification B are:

1. Specification A is slightly less accessible, which will be discussed later. In Specification A bathrooms, where multiple fixtures are provided, all must be usable and meet clearance requirements.
2. Specification B provides slightly more accessibility due to the greater accessibility required at the bathtub. In Specification B bathrooms, where multiple fixture types are provided, only one of each type is required to be usable and meet clearance requirements.

Lastly, the Guidelines provide designers choices with some limits, on how to apply Specifications A and B, to comply with the usable bathroom provisions in Requirement 7.

Example "A" Bathroom

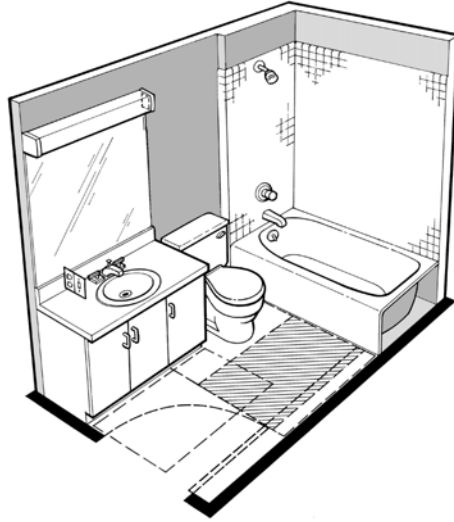

Example "A" Bathroom

This illustration shows a conventional in-line bathroom design that would comply with Specification "A". A distinguishing feature of a Specification "A" bathroom is that a toilet (or lavatory) is permitted to be located within the clear floor space adjacent to the bathtub.

In this illustration a toilet is allowed to be positioned next to the bathtub, making access to the bathtub limited.

Notes:

Example "B" Bathroom



Example "B" Bathroom

This illustration shows a bathroom design that would comply with Specification "B". The key feature is a 30"x48" clear floor space adjacent to the bathtub.

Neither a lavatory base cabinet nor a toilet are allowed to encroach on this clear floor space. Greater access is achieved for people using wheelchairs to transfer into and out of bathtubs.

Notes:

Dwelling Unit with One Bathroom

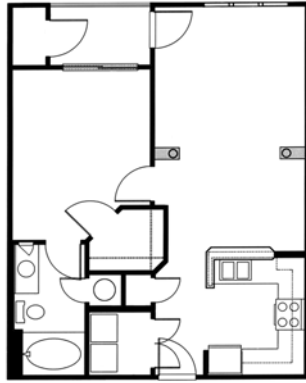

Design Choices:

- *Bathroom meets Specification A*

or

- *Bathroom meets Specification B*

Dwelling Unit with One Bathroom

In dwelling units with a single bathroom, the bathroom may be designed using Specification A or Specification B.

Notes:

Dwelling Unit with Multiple Bathrooms

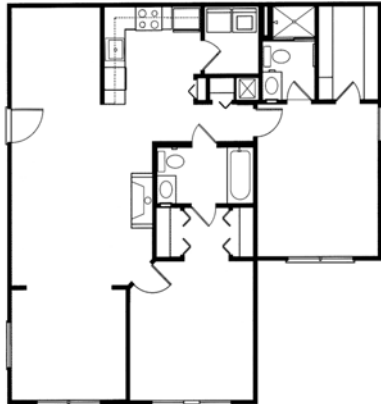

Design Choices:

1. *All bathrooms comply with Specification A*

OR

2. *One bathroom complies with Specification B and the other bathroom(s) not required to meet maneuvering and clear floor space requirements*

Dwelling Unit with Multiple Bathrooms

1. In dwelling units having multiple bathrooms, all bathrooms must at least comply with Specification A.

OR

2. One bathroom may be designed to comply with Specification B and the other bathroom(s) are not required to meet the maneuvering and clear floor space requirements at fixtures (Requirement 7).

However, bathrooms that are not required to comply with the maneuvering and clear floor space requirements must still:

- Have doors with a nominal 32" clear opening (Requirement 3)
- Be on an accessible route (Requirement 4)
- Have switches, outlets, and controls in usable locations (Requirement 5)
- Have reinforced walls around toilets, bathtubs, and shower stalls for grab bars (Requirement 6)

Specification A and B Requirements

- Specification A and B bathrooms require the following:
 - Clear floor space outside swing of door
 - Clear floor space at fixtures

Specification A and B Requirements

In Requirement 7, the Guidelines provide specifications for Specification A and B:

1. Clear floor space outside the swing of the door
2. Clear floor space at fixtures, including lavatories, water closets (toilets), bathtubs and showers.

Notes:

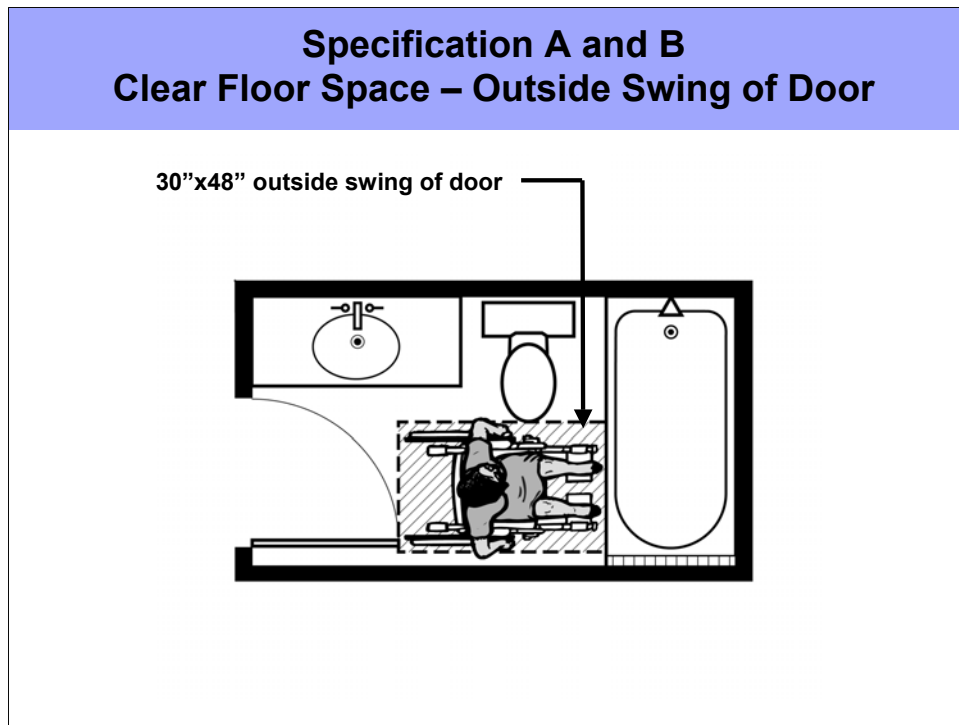

**Specification A and B
Clear Floor Space – Outside Swing of the Door**

Both Specification A and B bathrooms must have a 30" x 48" clear floor space outside the swing of the door. In meeting this requirement doors may swing in or out.

- In bathrooms with out swinging doors, all the required clear floor space at fixtures must still be provided.
- In bathrooms with in swinging doors, the door wing may overlap the clear floor space at fixtures but must not overlap the required 30" x 48" clear floor space outside the swing of the door.

Notes:

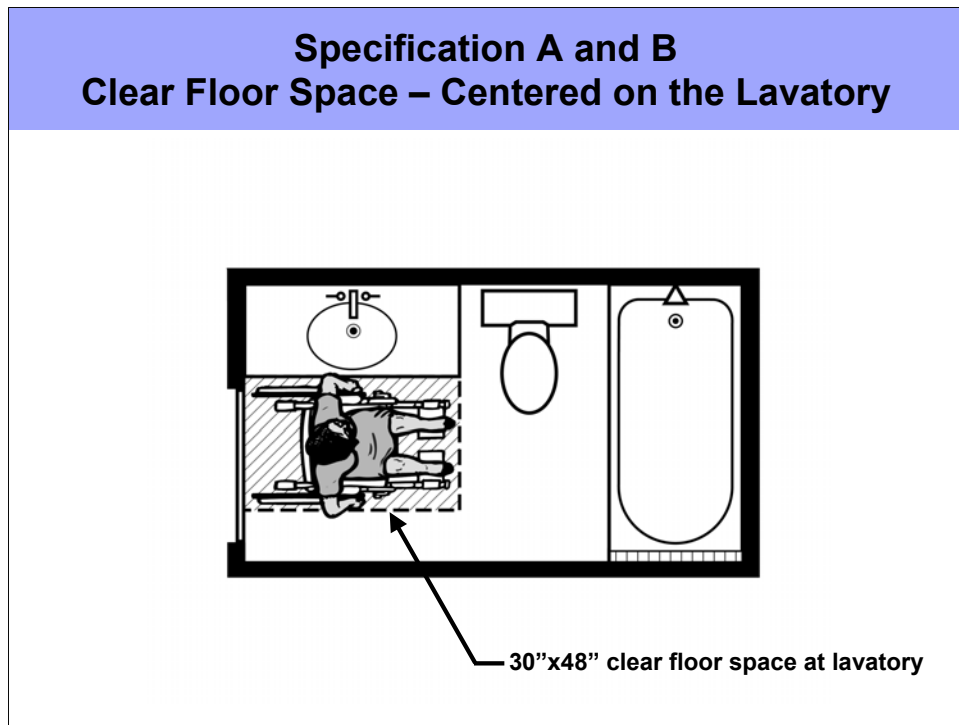

Specification A and B
Clear Floor Space – Centered on the Lavatory

Lavatories in Specification A and B bathrooms must have a 30" x 48" clear floor space parallel-to and centered-on the lavatory basin. This clear floor space permits a close parallel approach to the lavatory.

A forward approach to lavatories is also allowed. A forward approach must be 30" x 48" with the 30" dimension centered on the lavatory basin. Knee space at the lavatory must also be provided so a person using a wheelchair can make a close forward approach to reach the basin and faucets.

Notes:

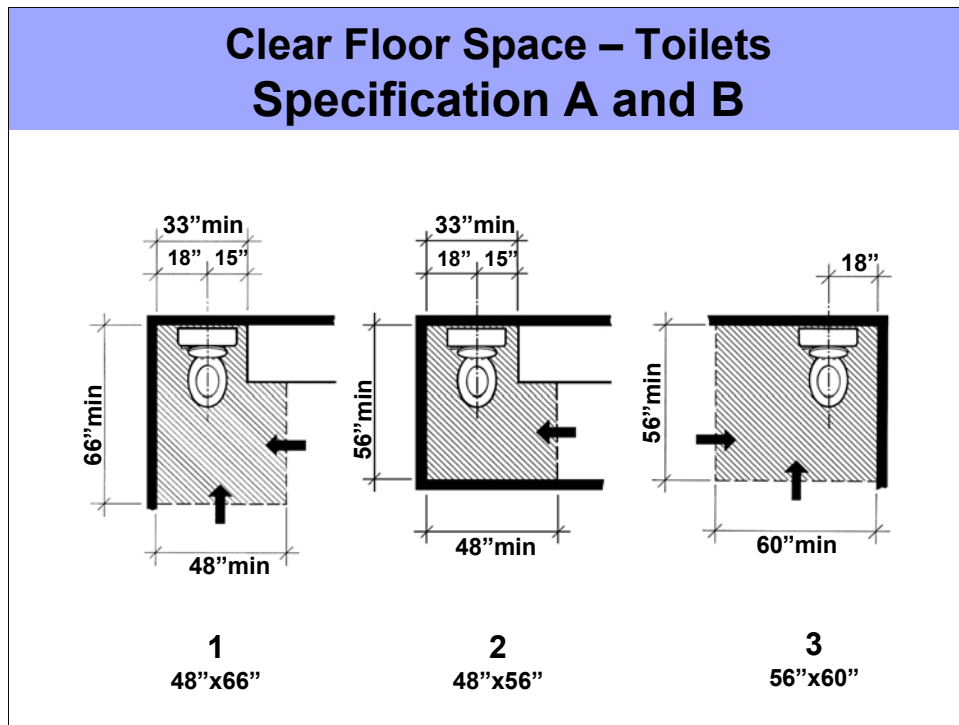

Clear Floor Space – Toilets Specification A and B

For Specification A and B bathrooms, the Guidelines provide three clear floor space options for providing maneuvering space at toilets.

Toilets in Specification A and B bathrooms must comply with one of the clear floor space options provided in the Guidelines. The choice of clear floor space will depend on the overall bathroom design and the direction of approach to the toilet. Provision of clear floor space at toilets is critical to allow people using wheelchairs, or other mobility aides, to approach the seat and make a safe transfer.

The three options are:

1. 48" x 66" for a forward and side approach
2. 48" x 56" for a side approach
3. 56" x 60" fully accessible, for a side or forward approach

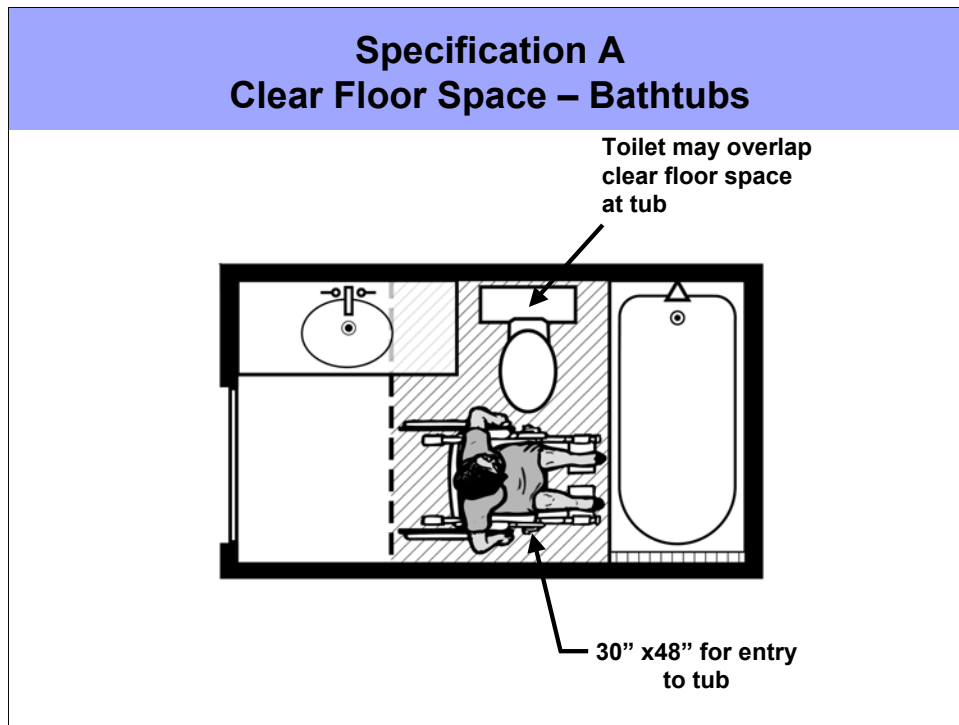

Specification A
Clear Floor Space – Bathtubs

The Guidelines provide two different clear floor space area options for Specification A bathrooms. One of the clear floor space areas is a 30" x 60" clear floor space area parallel to the tub.

The other clear floor space area provided in the Guidelines and illustrated in the slide, is a 48" x 60" clear floor area adjacent to the tub. In this clear floor space option, a toilet and part of the lavatory cabinet are allowed to overlap the 48" x 60" clear floor space at the tub. A minimum of 30" clearance must be maintained between the rim of the toilet and opposing wall to allow a forward approach to the bathtub.

Notes:

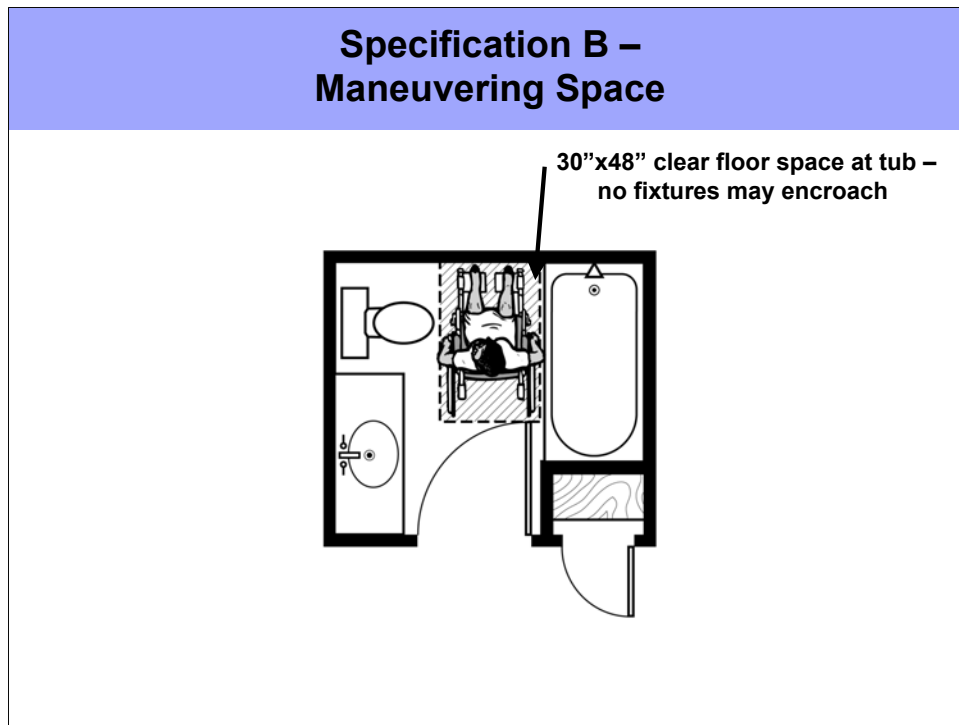

**Specification B –
Maneuvering Space**

Specification B bathrooms have the following maneuvering space requirements similar to Specification A bathrooms:

1. A 30" x 48" clear floor space outside the swing of the door. The door may swing in or out to accomplish this. If the door swings in, the swing may overlap clear floor space at fixture, but must not overlap the required 30" x 48" outside of the swing of the door.
2. A 30" x 48" clear floor space parallel-to and centered-on the sink. As in Specification A bathrooms, a forward approach is allowed if knee space is provided under the lavatory.
3. The toilet must be positioned within one of the three clear floor spaces provided in the Guidelines.

**Specification B –
Maneuvering Space (continued)**

The key differences between Specification A and B bathrooms are:

1. Specification B bathrooms must have a 30" x 48" clear floor space parallel to and adjacent to the bathtubs, beginning at the control wall. Unlike the 48" x 56" clear floor space in Specification A bathrooms, no fixtures or cabinet obstructions are allowed to overlap this clear floor space. There may be an adjacent wall hung sink at the foot of the tub, but the depth of fixture is limited to 19" and must have knee space. This makes transfers to the bathtub easier and is a more accessible design.
2. In Specification B bathrooms, if there are both a tub and a separate shower, only one has to be accessible and meet maneuvering space requirements of the Guidelines.

Notes:

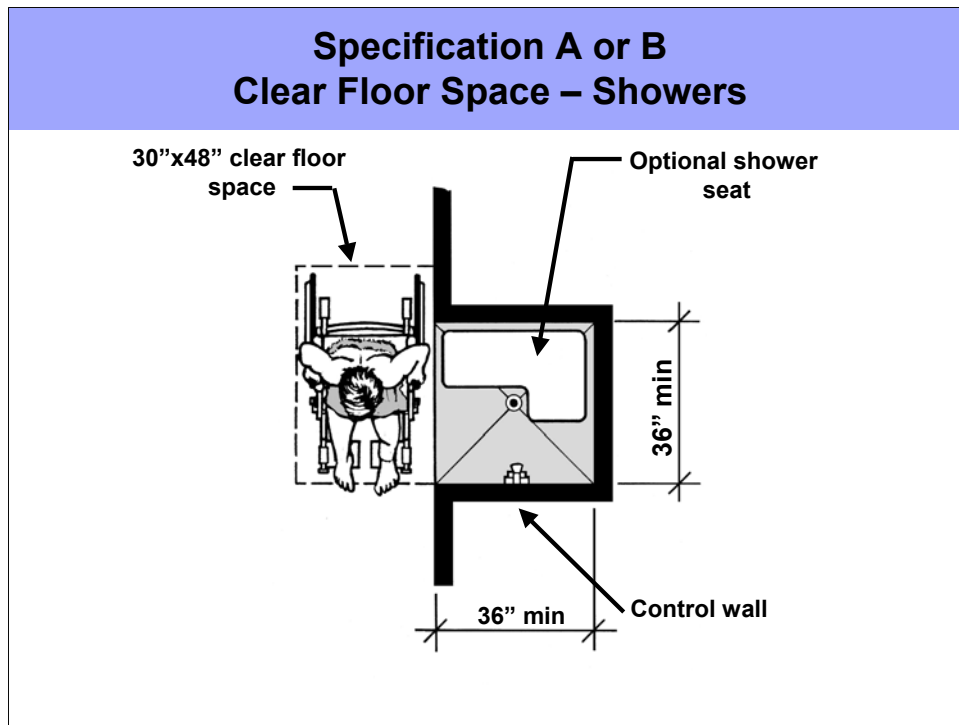

Specification A or B
Clear Floor Space - Showers

Shower stalls may be of any size or configuration except when:

1. The shower stall is the only bathing fixture in the dwelling; or
2. When the shower stall is designated the accessible bathing fixture in a Specification B bathroom.

In both of these exceptions, the Guidelines specify that the shower stall shall be a minimum of 36" x 36".

It must have a 30" x 48" clear floor space parallel to the stall and flush with the control wall. The shower wall opposite the controls must be reinforced to allow for installation of a wall-hung seat.

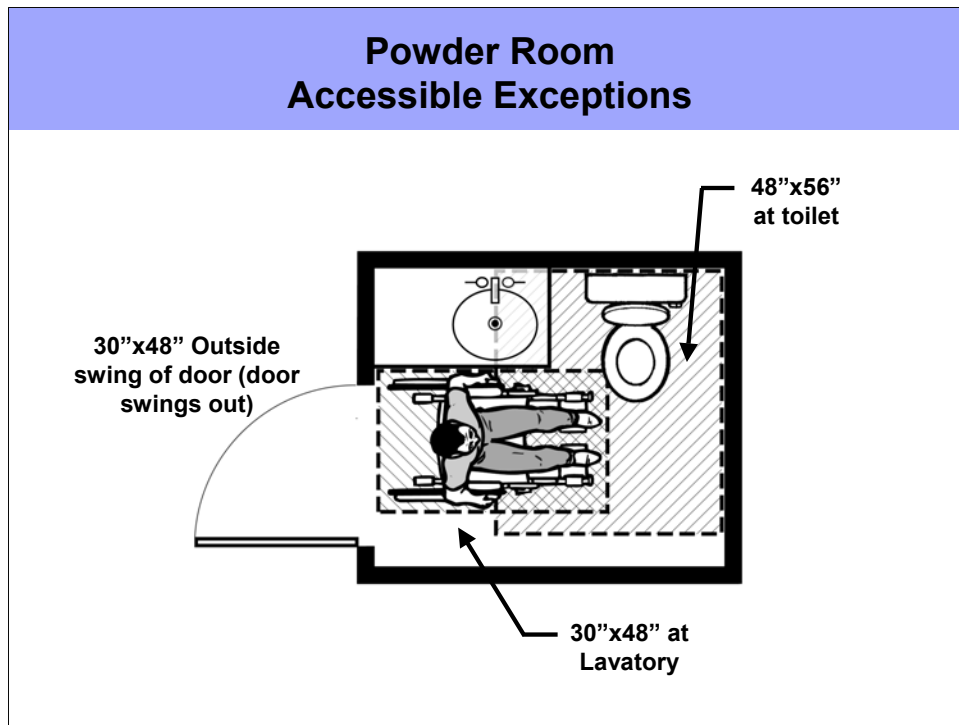

Powder Room Accessible Exceptions

Powder rooms, or ½ baths, do not meet the definition of a bathroom since they do not have a bathtub or shower, and therefore, are not subject to:

- Requirement 6 – Reinforcing for Grab Bars
- Requirement 7 – Usable Bathrooms, including maneuvering and clear floor space

However, they are subject to:

- Requirement 3 – Usable Doors
- Requirement 4 – Accessible Routes
- Requirement 5 – Outlets and Switches in Usable Locations

An exception to this, as illustrated in this slide, is when a powder room is the only toilet facility provided on the accessible level of a multi-story unit in an elevator building. In these situations the powder room must comply with Requirements 3-7 as discussed above.

Powder Room (continued)

In this example, note:

1. There is a 30" x 48" clear floor space outside the swing of the door – because the door swings out.
2. There is a 30" x 48" clear floor space parallel to and centered on the lavatory.
3. There is a 48" x 56" clear floor space at the toilet for a side approach.

Notes:

	<h2>Technical Overview - Agenda</h2> <ul style="list-style-type: none">• Overview the Fair Housing Act• Technical Requirements of the Fair Housing Act• Strategies for Compliance• Resources
---	--

Notes:

Avoid Problems with Non-Compliance

- Identify the issue early
- Assign responsibility
- Monitor activities
- Use your resources
- Get help
- Don't count on state or local code compliance
- Correct problems promptly
- Remember the consequences

Avoid Problems with Non-Compliance

There are some important ways to avoid design and construction pitfalls:

- Identify the obligation to comply with the Fair Housing Act's design and construction requirements early in the process and incorporate them into pre-plan activities.
- Assign responsibility for compliance and require all of the players — whether engineers, architects, builders or designers — to be aware of and responsive to their obligations.
- Monitor each stage of the planning, development, and construction of the property for compliance. Ask the hard questions.
- Use the information and resources you have been given in this training.
- Get help when help is needed.

Avoid Problems with Non-Compliance (continued)

- Don't count on the fact that local or state officials, HUD, or other federal, state or local officials have approved plans, issued permits or approved construction activities for compliance. They are not necessarily checking for Fair Housing Act compliance.
- When problems are identified, correct them promptly and according to standard.
- Remember the consequences if the law is not followed.

Notes:

Exercise – Identifying Non-Compliant Features

Exercise Objective:

To strengthen knowledge of the Fair Housing Act accessibility requirements by applying them to real-life scenarios.

Exercise Assignment:

Analyze and identify the non-compliant features of the photographs on the following pages with your small group.

Exercise



Non-Compliant Features

Exercise



Non-Compliant Features

Exercise



Non-Compliant Features

Exercise



Non-Compliant Features

Summary of Requirements

1. Accessible building entrance on an accessible route
2. Accessible and usable public and common use areas
3. Usable doors
4. Accessible routes into and through covered unit
5. Light switches, electrical outlets, thermostats, and other environmental controls in accessible locations
6. Reinforced walls for later installation of grab bars
7. Usable kitchens and bathrooms



Summary of Requirements

In summary, here, once again are the seven design requirements specified in the Guidelines:

- Requirement 1: Accessible Building Entrance on an Accessible Route
- Requirement 2: Accessible and Usable Public and common use Areas
- Requirement 3: Usable Doors
- Requirement 4: Accessible Route into and through the Covered Unit
- Requirement 5: Light Switches, Electrical Outlets, Thermostats, and other Environmental Controls in Accessible Locations
- Requirement 6: Reinforced Walls for Later Installation of Grab Bars
- Requirement 7: Usable Kitchens and Bathrooms

Advantages of Compliance



Advantages of Compliance

Skillful integration of the seven requirements into the design of housing covered by the Fair Housing Act's design and construction requirements can produce attractive, highly marketable units that offer functional advantages to everyone, not just people with disabilities.

Notes:

	Technical Overview - Agenda
•	Overview of the Fair Housing Act
•	Technical Requirements of the Fair Housing Act
•	Strategies for Compliance
•	Resources

Notes:

Fair Housing Act Accessibility Resources **FIRST**

Fair Housing Accessibility **FIRST**
Information Line
1-888-341-7781 V/TTY



Fair Housing Accessibility FIRST
Website
www.FairHousingFIRST.org



Notes:



Comprehensive Training Curriculum

Course Title	Time (hours)
Fair Housing Act Accessibility Requirements Overview	1 (Short) or 4 (Long)
Design and Construction Requirements of the Fair Housing Act: Technical Overview	3
Disability Rights Laws	1.5
Fair Housing Act Enforcement	1.5
Strategies for Compliant Kitchens	1.5
Strategies for Compliant Bathrooms	1.5
Accessible Routes	1.5
Accessible Public and Common Use Areas	1.5
Common Design and Construction Violations and Solutions	1.5
Making Housing Accessible Through Accommodations and Modifications	1.5

**www.FairHousingFIRST.org
(888) 341-7781**



Fair Housing Act and Related Standards

Standard	Where to Obtain
Fair Housing Act as Amended (Title VIII of the Civil Rights Act)	www.FairHousingFIRST.org (888) 341-7781 (V/TTY)
Fair Housing Act Guidelines*	www.FairHousingFIRST.org (888) 341-7781 (V/TTY)
Fair Housing Act Design Manual*	Disseminated at training www.huduser.org (800) 245-2691 TDD: (800) 483-2209
International Building Code*	www.intlcode.org (703) 931-4533
ANSI A117.1 (1986)*	www.intlcode.org (703) 931-4533
CABO/ANSI A117.1 (1992)*	www.bocai.org (800) 214-4321
ICC/ANSI A117.1 (1998)*	www.intlcode.org (703) 931-4533
Code Requirements for Housing Accessibility 2000 (CRHA)*	www.bocai.org (800) 214-4321
Section 504 of the Rehabilitation Act	www.hudclips.org (301) 519-5395
Uniform Federal Accessibility Standards	www.access-board.gov (800) 872-2253, TTY: (800) 872-2253
Architectural Barriers Act of 1968	www.access-board.gov (800) 872-2253, TTY: (800) 872-2253
Americans with Disabilities Act of 1991, Title II and Title III	www.access-board.gov (800) 872-2253, TTY: (800) 872-2253
ADA Accessibility Guidelines	www.access-board.gov (800) 872-2253, TTY: (800) 872-2253

**Denotes HUD Safe Harbor*

Publications

Listed in alphabetical order with the following designations based on topic.

C – Code; D – Design; L – Legal; DA – Disability Advocacy

Type	Resource Name	Description	Where to Obtain
D	Accessible Cabinetry	Describes state-of-the-art cabinetry designed to facilitate use by people with disabilities.	www.design.ncsu.edu/cud/ (800) 647-6777 (voice or TTY)
D	Accessible Environments: Toward Universal Design	Overview of the concept of universal design in everyday environments. Contains design illustrations and history of the disability rights movement.	www.design.ncsu.edu/cud/ (800) 647-6777 (voice or TTY)
D	Accessible Plumbing	Describes state-of-the-art in accessible plumbing fixtures and accessories.	www.design.ncsu.edu/cud/ (800) 647-6777 (voice or TTY)
D	Accessible Stock House Plans Catalog	Contains floor plans and perspectives for six accessible homes.	www.design.ncsu.edu/cud/ (800) 647-6777 (voice or TTY)
D	A Consumer's Guide to Home Adaptation	Includes worksheets for evaluating needs in the home, illustrated construction plans for grab bars, ramps, and other accessible elements, and resource listings for products.	www.design.ncsu.edu/cud/ (800) 647-6777 (voice or TTY)
C	HUD Review of Model Building Codes Final Report		www.hud.gov/offices/ftheo/disabilities/modelcodes/
DA	New Mobility Magazine		www.newmobility.com
L	The New Fair Multifamily Housing: A Design Primer to Assist in Understanding the Accessibility Guidelines of the FHAct	Provides a basic understanding of the accessibility requirements of the FHAct. Also includes illustrated solutions and examples from existing projects.	www.design.ncsu.edu/cud/ (800) 647-6777 (voice or TTY)
L	Rights and Responsibilities of Tenants and Landlords under the Fair Housing Amendments Act	Outlines the rights and responsibilities of tenants with disabilities and landlords under the FHAct.	www.design.ncsu.edu/cud/ (800) 647-6777 (voice or TTY)
D	Tenant's Guide to Apartment Modifications: An Idea Source Pamphlet to Simple, Low-cost Modifications to Increase Accessibility in Apartments	Presents illustrated ideas for low-cost modification that are commonly made to rental dwellings.	www.design.ncsu.edu/cud/ (800) 647-6777 (voice or TTY)

Websites and Organizations

Listed in alphabetical order with the following designations based on topic.

C – Code; D – Design; DA – Disability Advocacy; G – Government; L – Legal; T – Trade ; O – Other

Type	Organization	URL
O	American Association of Retired Persons	www.aarp.org
DA	American Association of People with Disabilities	www.aapd.org
G	Access Board	www.access-board.gov
C	Adaptive Environments	www.adaptenv.org
DA	American Association of People with Disabilities	www.aapd-dc.org
T	American Bankers Association	www.aba.com
T	American Bar Association	www.abanet.org
DA	American Disabled for Attendant Programs Today	www.adapt.org
T	American Institute of Architects	www.aia.org
DA	American Seniors Housing Association	www.seniorshousing.org
T	American Society of Civil Engineers	www.asce.org
T	American Society of Interior Designers	www.asid.org
L	Bazelon Center for Mental Health Law	www.bazelon.org
D	Bob Vila	www.bobvila.com - special features
D	Center for Inclusive Design and Environmental Access	www.ap.buffalo.edu
D	Center for Universal Design	www.design.ncsu.edu/cud/index.html
G	Centers for Medicare and Medicaid Services	www.cms.gov
DA	Consortium for Citizens with Disabilities	www.c-c-d.org
D,L	Cornucopia of Disability Information (CODI)	www.codi.buffalo.edu
G	Department of Agriculture	www.usda.gov
G	Department of Justice	www.usdoj.gov
G	Department of Treasury	www.treasury.gov
DA	Disability Rights Action Coalition for Housing	www.libertyresources.org/housing/nac.html
DA	Eastern Paralyzed Veterans Association	www.epva.org
T	Institute for Real Estate Management	www.irem.org
C	International Code Council	www.intlcode.org
L	The John Marshall Law School Fair Housing Legal Support Center	http://law170.jmls.edu/
D	NAHB Research Center	www.nahbrc.org
T	National Affordable Housing Mgmt. Assoc.	www.nahma.org
T	National Apartment Association	www.naahq.org
T	National Association of Home Builders	www.nahb.org
T	National Association of Realtors	www.nar.realtor.com
T, D	National Association of the Remodeling Industries	www.nari.org
G	National Council on Disability	www.ncd.gov
C	National Conference of States on Building Codes and Standards (NCSBCS)	www.ncsbc.org
DA, L	National Fair Housing Advocate Online	www.fairhousing.com
DA	National Fair Housing Alliance	www.nationalfairhousing.org
D	National Kitchen and Bath Association	www.nkba.org
T	National Low Income Housing Coalition	www.nlihc.org
T	National Multi Housing Council	www.nmhc.org
DA	National Organization on Disability	www.nod.org
D, DA	National Resource Center on Supportive Housing and Home Modification	www.homemods.org
DA	Paralyzed Veterans of America	www.pva.org
D	Technical Assistance Collaborative	www.toolbase.org
DA	Wemedia	www.wemedia.com
DA	World Institute on Disability	www.wid.org